



22.01

SALICE

bisagra serie B cristal

ACERO

	cierre	apertura		SK	
CBG2A99	muelle	110°	511.811.843	✓	1
PUSH	muelle	push	511.298.099	p	150

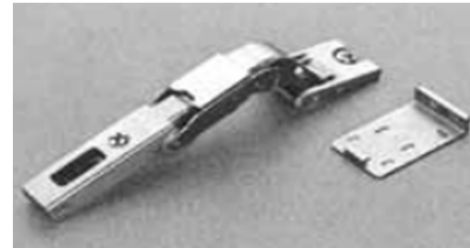

Regulaciones:

- Regulación lateral compensada de -1,5 a +4,5 mm.
- Regulación vertical +/- 2 mm.
- Regulación frontal con bases Serie 200 +2,8 mm.
- Regulación frontal con bases Domi de -0,5 a +2,8 mm
- Apertura 110° con movimiento a 7 ejes.
- Bisagras para puertas de cristal.

No requiere ningún taladro para el montaje.

Soluciona diferentes aplicaciones a través de un producto tecnológicamente muy avanzado.

La cazoleta está formada por dos partes, la primera de pegar al interior de la puerta de cristal por medio de un adhesivo especial, y la segunda (bisagra) de enganchar a la primera por medio de una excéntrica.

Variando la posición de la placa pegada sobre el cristal, es posible efectuar cualquier tipo de montaje. "K" desde 0 hasta 22mm.

Brazo recto = codo 0. Valor constante "L" 0,7mm; no cambia regulando lateralmente la bisagra.

NO REQUIERE NINGÚN TALADRO PARA EL MONTAJE.

La placa se fija al cristal o espejo con un adhesivo especial.

Declinación de responsabilidad.

Las bisagras SALICE "Serie B" (CBG) han sido estudiadas para ser utilizadas sobre puertas de cristal o espejos.

SALICE y GLOBAL ALAYBE no asumen la responsabilidad por cualquier inconveniente derivado del tipo de adhesivo utilizado, del procedimiento de pegado, o bien de una incorrecta instalación y relativas consecuencias.

Se aconseja efectuar pruebas preliminares con el adhesivo seleccionado. Si la placa, sometida a una fuerza de torsión superior a 160 Nm, queda bien fija, el adhesivo puede ser considerado apropiado

SECUENCIAS DE MONTAJE

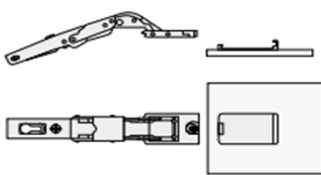

1.- Fijar la placa a la puerta (cristal o espejo) con un adhesivo especial. Se aconseja de realizar esta operación por empresas especializadas. Para ulteriores informaciones sobre el adhesivo y su aplicación, Vds pueden dirigirse directamente a su proveedor de adhesivos especiales o al de puertas de cristal.

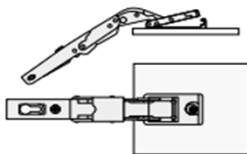

2.- Cuando la placa está bien fijada, enganchar la bisagra.

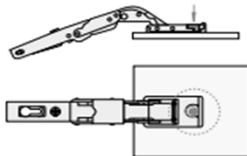

3.- Posicionar la cazoleta de la bisagra sobre la placa y hacer una rotación de la excéntrica.

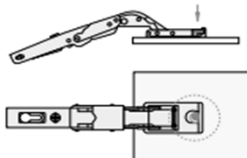

4.- Ahora la bisagra está bien fijada a la puerta.

COBERTURA

K = 0 - 22

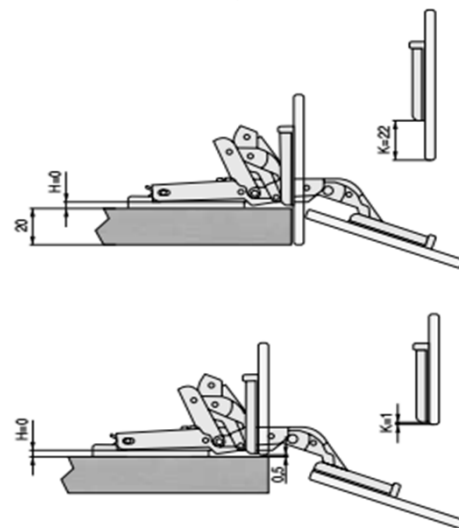

bisagras especiales



a

✓ = stock

p = bajo pedido



22.01 bisagra cazoleta D:26 mm cristal 95º

ACERO/PLASTICO



fijacion	tipo	codo	cierre	apertura	cincado	SK	
atornillar	recta	3	muelle	95º	511.298.260	✓	1
atornillar	acodada	9	muelle	95º	511.298.261	✓	1
atornillar	s/acodada	17	muelle	95º	511.298.262	✓	1

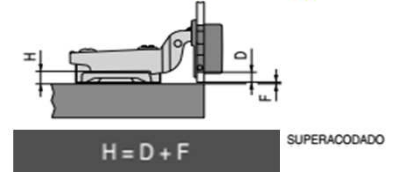
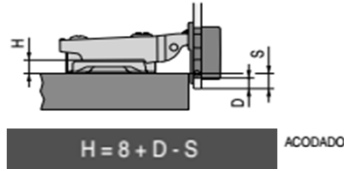
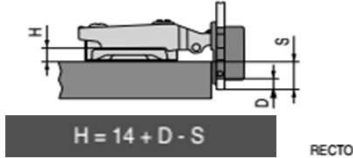

D máx. = 7,0mm.

Espesor del cristal Glass thickness T mín. = 3,5mm. T máx. = 6,0mm.	D = Distancia de taladro de la cazoleta Cup drilling distance S = Cobertura Overlay F = Fuga Gap X = Distancia fijación de la base Plate fixing distance H = Altura de la base Mounting plate height
---	--

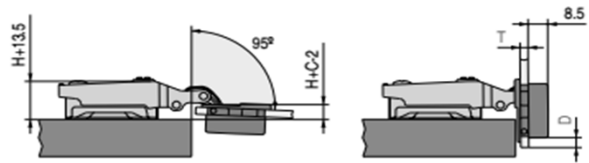

accesorios bisagra cazoleta D:26 mm cristal 95º

ACERO/PLASTICO

descripcion		chromo	oro	níquel RAL	SK	
placa/embellecedor	511.298.187	511.298.185	511.298.183	511.298.186	✓	1
anillo	511.298.184				✓	1
tornillos	511.298.181				✓	1

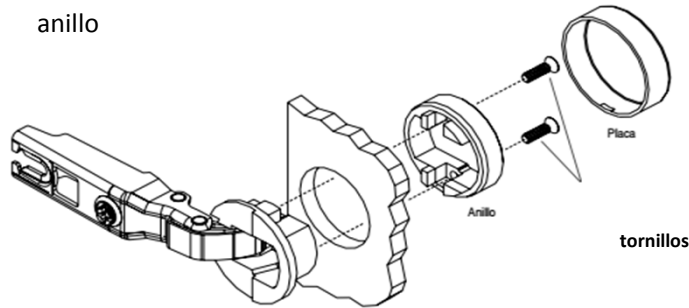

La fijación de la puerta de cristal a la bisagra es por medio del anillo de plástico que aprieta con dos tornillos la cazoleta de la bisagra. El anillo y los tornillos quedan completamente ocultos con la placa embellecedora.

base bisagra cazoleta D:26 mm cristal 95º

ACERO

regulacion	fijacion	cierre	altura	níquel RAL	SK	
manual	atornillar	slide-on	4,5	511.298.141	✓	1

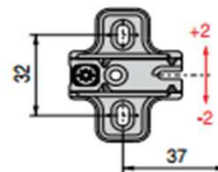



22.02

bisagra cazoleta FRAME 50 especial marco estrecho

ACERO

descripcion	alt.	cierre	apertura	SK	
bisagra		muelle	105º	511.811.826	✓ 1/500
base	3			511.811.830	✓ 1/500

Base para bisagra

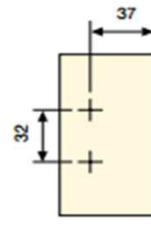
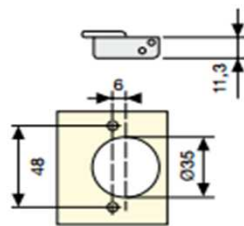
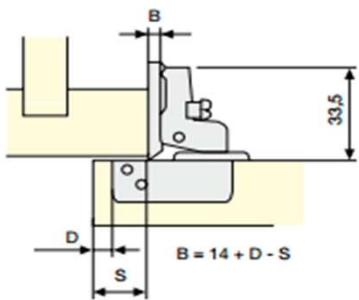

bisagra doble cazoleta inglete d:35

descripcion	cierre	apertura	SK	
bisagra	muelle	120º	511.298.128	✓ 1/25



- Inglete de 45° •
- Ajuste en altura de 3mm., ajuste en ancho y profundidad 1,5mm.
- Grosor de la puerta 16 a 22 mm.
- Grosor de pared lateral 16 a 20 mm, a partir de 20mm es preciso biselar el canto 3mm.

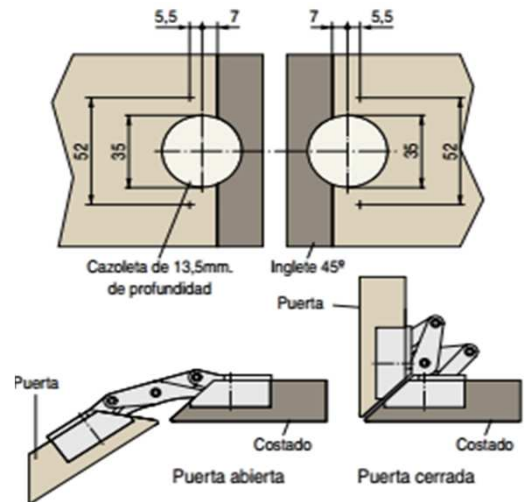
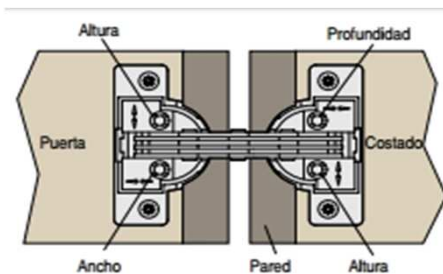



22.02 bisagra doble cazoleta rincon



descripcion	cierre			
bisagra	muelle	511.811.310	✓	1

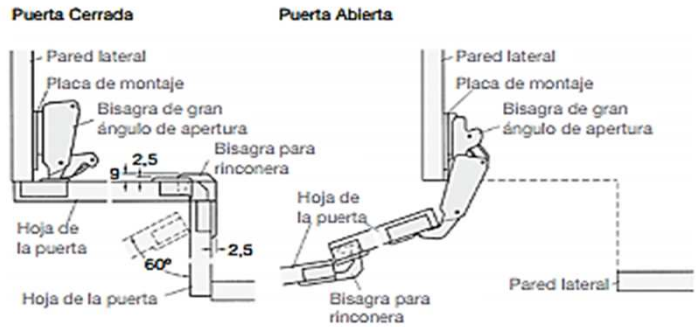
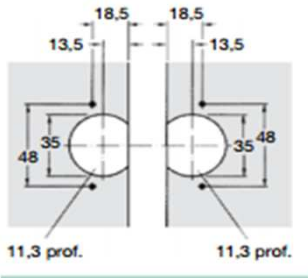

bisagra kimana ascendente y descendente

ZAMAK



ITALIANA

descripcion	NIQUELADO	SK	
bisagra	524.811.912	✓	1
separador H=1,5	524.811.923	✓	1
separador H=3,0	524.811.934	✓	1
separador H=4,0	524.811.945	✓	1

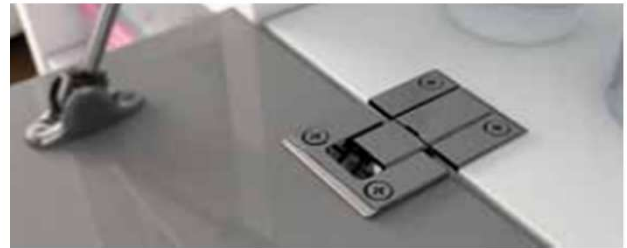
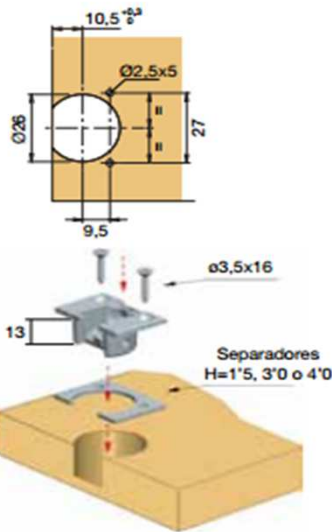

bisagras especiales

bisagra embutida decorativa 32mm



regul.	efecto inox	niquelado	cuero	SK	
no	525.557.125	525.557.105	525.557.115	✓	10/100
si	525.557.126	525.557.106	525.557.116	✓	10/100

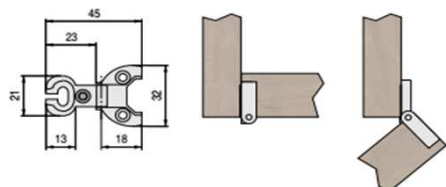

p= bajo pedido

✓ = stock



bisagra cazoleta DECORATIVA d:35

ZAMAK

descripc	acabado	cierre	remate		SK	
bisagra	cuero	golpete	si	513.557.113	✓	1/100
bisagra	gris	golpete	si	513.557.114	✓	1/100
bisagra	gris	golpete	no	513.557.115	✓	1/100

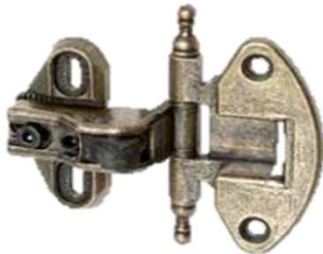

detalle sin remate

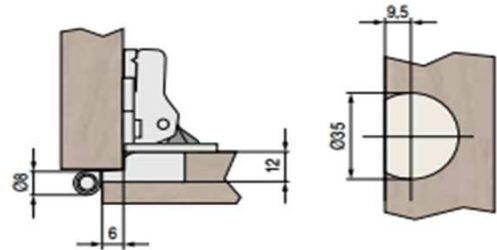

bisagra DECORATIVA D:35 REGULABLE

ZAMAK

descripc	acabado	cierre	remate		SK	
bisagra	bronce	golpete	si	513.298.423	✓	1/100

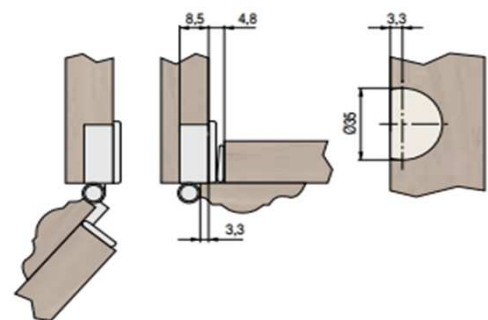
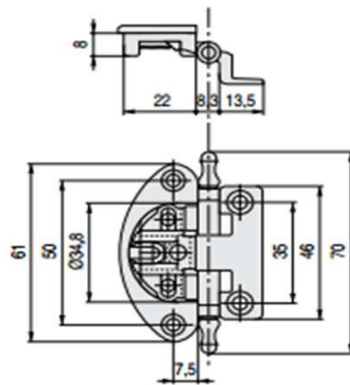

Regulación vertical, lateral y frontal.

bisagra embutida decorativa 32mm 3 regulaciones

ZAMAK

oro viejo	Cromo ral 9006	níquel	SK	
525.298.056	525.298.057	525.298.058	✓	10/500

oro viejo



Cromo RAL 9006

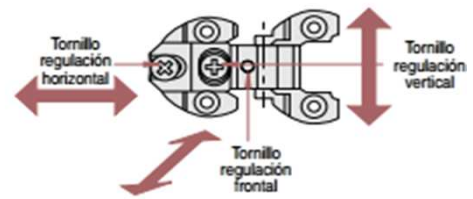
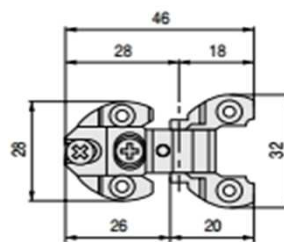
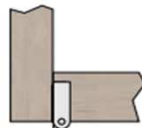

Regulación vertical, lateral y frontal.

bisagra DONCEL con remate 32mm 3 regulaciones

ZAMAK

oro viejo	Cromo ral 9006	níquel	SK	
525.298.061	525.298.062	525.298.063	✓	1/500

níquel



oro viejo

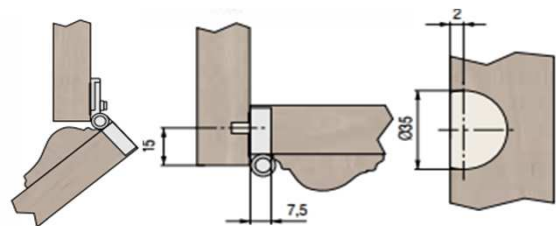
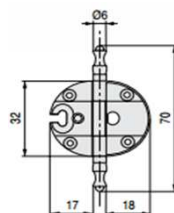



22.02 bisagra DONCEL sin remate 32mm 3 regulaciones

ZAMAK

oro viejo	chromo ral 9006	níquel		
525.298.153	525.298.195	525.298.127	✓	1

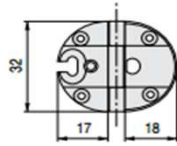

níquel

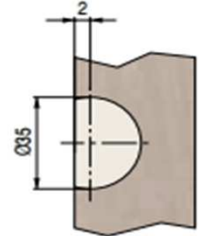
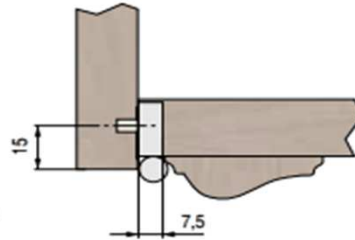
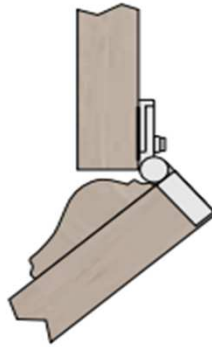

bisagra cazoleta ALMAGRO d:35

ZAMAK

acabado	remate		SK	
oro viejo	si	525.298.516	✓	1/500
oro viejo	si	525.298.518	✓	1/500
níquel	no	525.298.519	✓	1/500

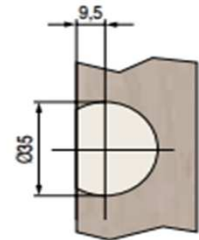
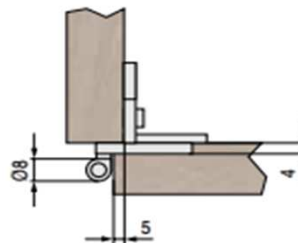
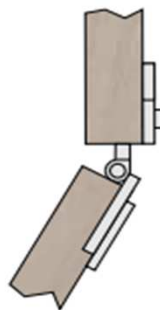
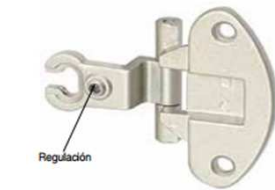
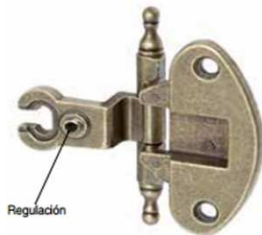

bisagra cazoleta CIFUENTES d:26

ZAMAK

acabado	remate		SK	
oro viejo	si	525.298.525	✓	1/300
plata vieja	si	525.298.526	✓	1/300

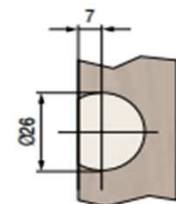
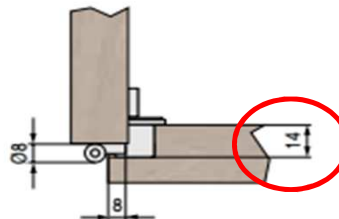
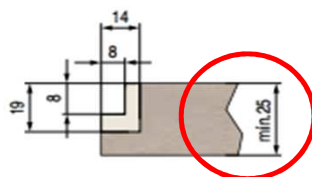



22.02

bisagra cazoleta HITA d:26

ZAMAK

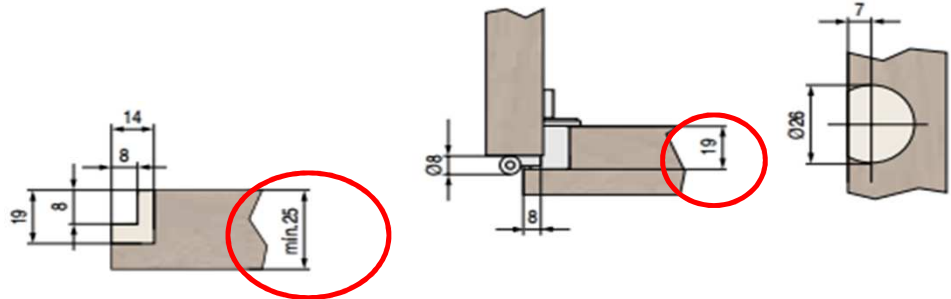
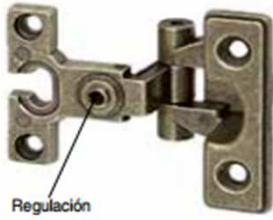

acabado	remate		SK	
oro viejo	no	525.298.521	✓	1/350
níquel	no	525.298.520	✓	1/350

bisagra cazoleta LAYNA d:26

ZAMAK

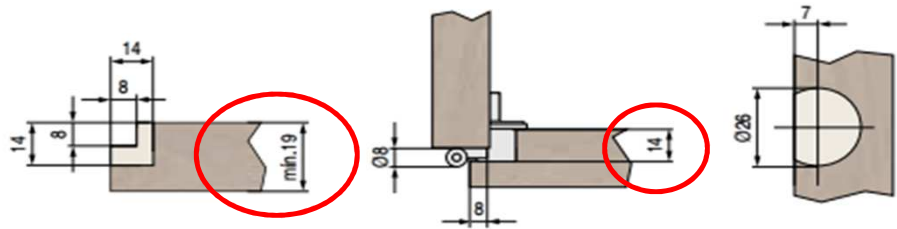

acabado	remate		SK	
oro viejo	no	525.298.523	✓	1/350
níquel	no	525.298.527	✓	1/350

bisagra cazoleta SINGER

ZAMAK



acabado	apertura		SK	
níquel	90°	525.298.024	✓	1/20

- Regulaciones, vertical, profundidad y altura.
- Desmontable.
- Se pueden montar las distintas cazoletas por separado y luego unirlas para facilitar el montaje.
- Para taladros de Ø35mm. con pestaña embellecedora para tapan el borde de los agujeros.

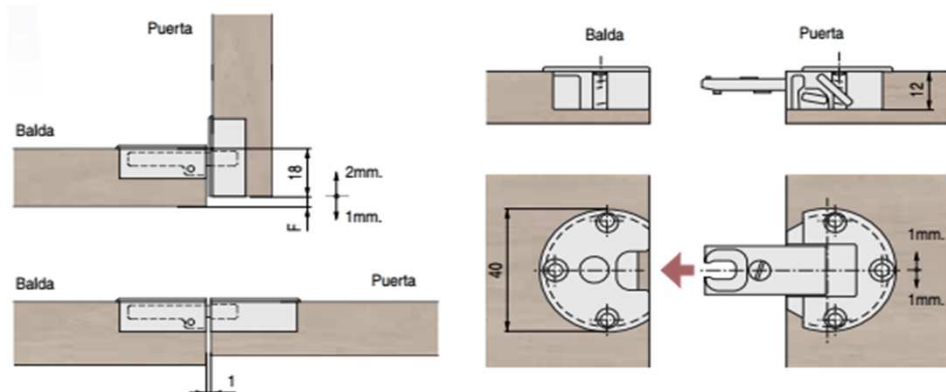
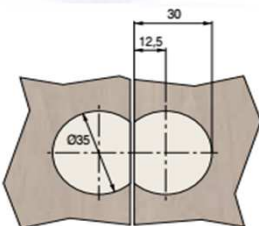



bisagra cazoleta cristal

22.02 bisagra RIBA doble cazoleta 180°

ZAMAK

acabado

niquel

525.298.224



1/100

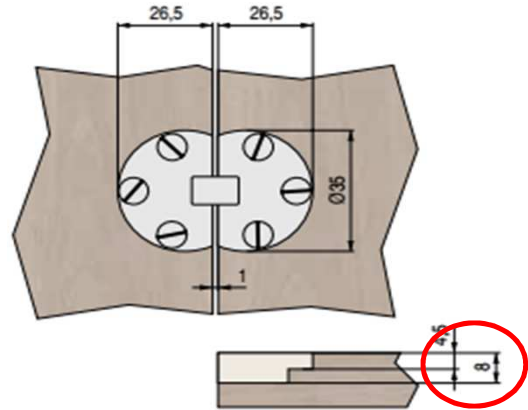
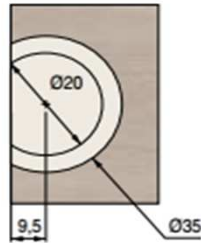

bisagra CLARES doble cazoleta 180°

ZAMAK



acabado

latonado

525.298.014



1/150

niquel

525.298.015



1/150

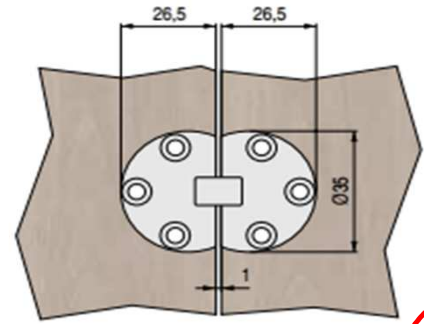
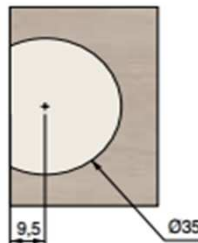

bisagra SELAS para tapa de mesas

PLASTICO/ZAMAK

acabado

marron

525.298.814



1/50

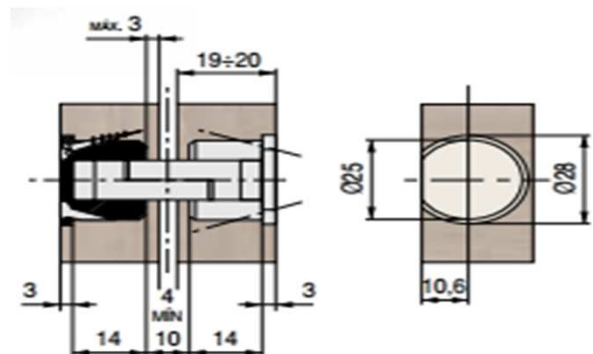

bisagras especiales



f

p= bajo pedido

✓ = stock