



23.07



torno giratorio 360º

alto	ancho	fondo	mueble	SK	
650/750	785	705	M-90	217.874.011	✓ 1

- Solución para esquinas de rincón en forma de L
- Las cestas centrales son extraíbles
- Todo el herraje gira sobre sí facilitando el acceso
- Capacidad de carga 30 kg no recomendable superar los 4 kg por cesta

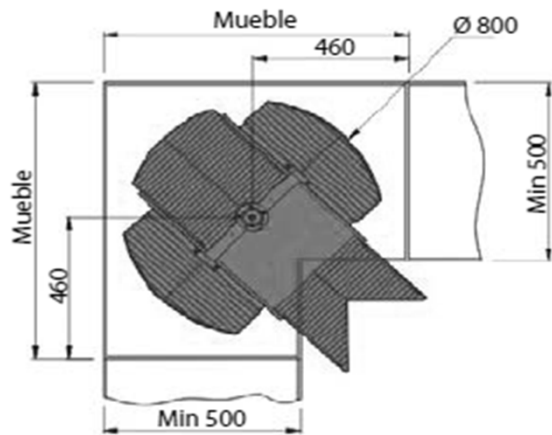
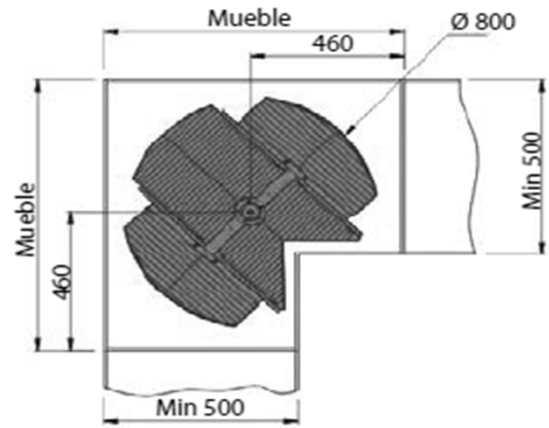

modelo metalico

modelo varilla

✓ = stock

p = bajo pedido





23.07

torno giratorio 3/4 madera



- Solución para esquinas de rincón en forma de L
- Las cestas giran independientemente
- Disponible en base de madera o varillas
- Capacidad de carga por cesta 15 kg

alto	ancho	fondo	mueble		SK	
600/730	813	737	M-90	215.874.007	✓	1
600/730	713	652	M-80	217.874.009	✓	1

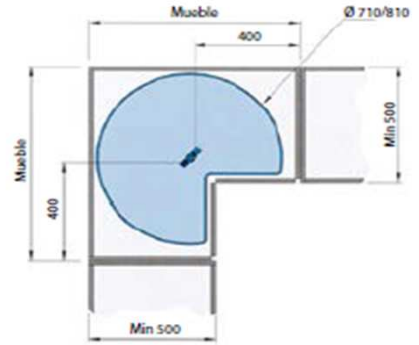

torno giratorio 3/4 varilla



- Solución para esquinas de rincón en forma de L
- Las cestas giran independientemente
- Disponible en base de madera o varillas
- Capacidad de carga por cesta 15 kg

alto	ancho	fondo	mueble		SK	
600/730	813	737	M-90	217.874.008	✓	1
600/730	713	652	M-80	217.874.010	✓	1

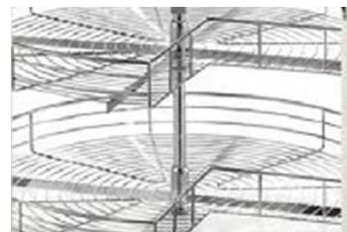
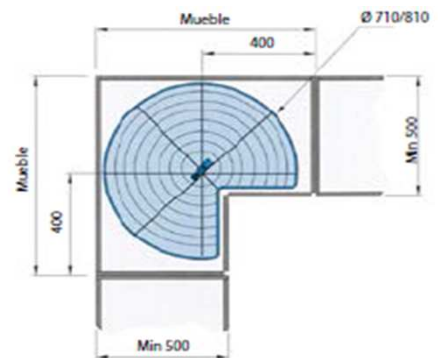



esquinero oscilante varilla

- Para muebles esquina de rincón ciego
- Accede de forma sencilla a todos tus utensilios
- Disponible en varilla redonda y fondo gris o varilla plana y fondo blanco
- Carga máxima de 20 kg, no recomienda sobrepasar los 10 kg por cesta

mano	alto	ancho	fondo	mueble		SK	
izquierda	600/730	785	475	M-90	217.874.001	✓	1
derecha	600/730	785	475	M-90	217.874.002	✓	1
izquierda	600/730	960	480	M-110/120	217.874.003	✓	1
derecha	600/730	960	480	M-110/120	217.874.004	✓	1



Para mueble bajo
Con varilla redonda y fondo gris



Modelo mueble 1100/1200 mm

esquinero oscilante SEMICOLUMNA varilla

- Para muebles esquina de rincón ciego
- Accede de forma sencilla a todos tus utensilios
- Disponible en varilla redonda y fondo gris o varilla plana y fondo blanco
- Carga máxima de 20 kg, no recomienda sobrepasar los 10 kg por cesta

mano	mueble	ancho	fondo	alto		SK	
izquierda	M-90	785	475	1200/1380	218.874.001	✓	1
derecha	M-90	785	475	1200/1380	218.874.002	✓	1



Para mueble semicolumna
Con varilla redonda y fondo gris



modelo metalico





23.07 esquinero oscilante varilla plana



- Para muebles esquina de rincón ciego
- Accede de forma sencilla a todos tus utensilios
- Disponible en varilla redonda y fondo gris o varilla plana y fondo blanco
- Carga máxima de 20 kg, no recomienda sobrepasar los 10 kg por cesta

mano	alto	ancho	fondo	mueble		SK	
izquierda	600/730	785	475	M-90	217.874.034	✓	1
derecha	600/730	785	475	M-90	217.874.035	✓	1
izquierda	600/730	960	480	M-110/120	217.874.036	✓	1
derecha	600/730	960	480	M-110/120	217.874.037	✓	1

Para mueble bajo
Con varilla plana y fondo blanco



Modelo mueble 1100/1200 mm



APERTURA
DERECHA

217.874.002
217.874.349
217.874.535

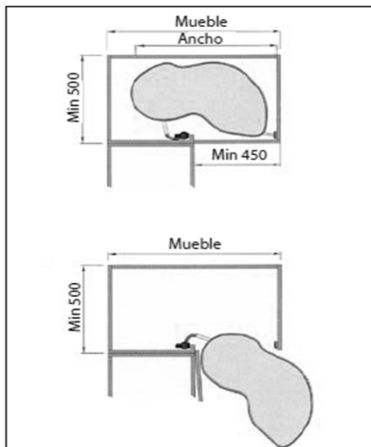

APERTURA
DERECHA

217.874.004
217.874.537

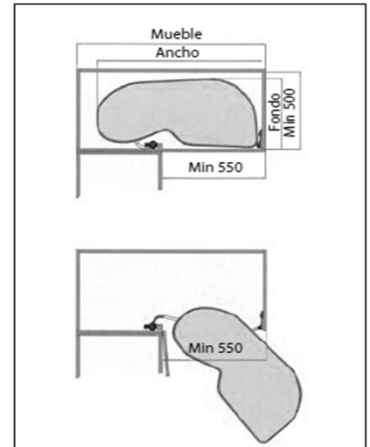

APERTURA
IZQUIERDA

217.874.001
217.874.348
217.874.534

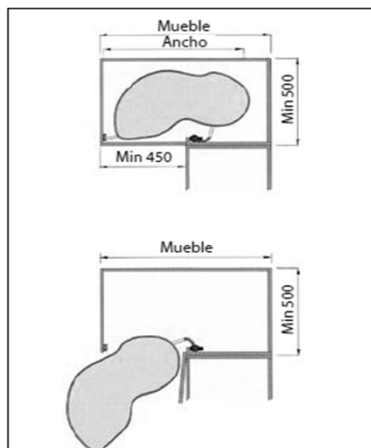

APERTURA
IZQUIERDA

217.874.003
217.874.536

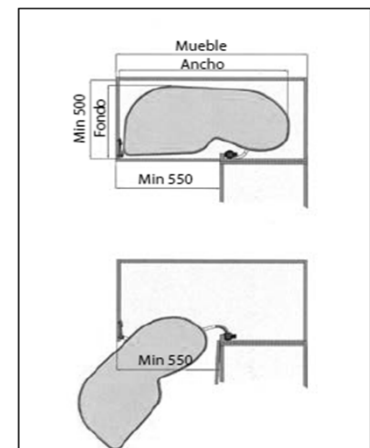



magic corner cestas madera



minimo pl	mano	ancho	fondo	alto	mueble		SK	
450	izquierda	860	510	620/750	M-90	217.874.441	✓	1
450	derecha	860	510	620/750	M-90	217.874.442	✓	1

- Para muebles esquina de rincón ciego
- Accede de forma sencilla a todos tus utensilios
- Herraje extraíble a la apertura de la puerta
- Cierro suave gracias a sus guías Soft Close
- Carga máxima de 25 kg, no recomienda sobrepasar los 6 kg por cesta



Cestas con base de madera

magic corner cestas varilla



minimo pl	mano	ancho	fondo	alto	mueble		SK	
450	izquierda	860	510	620/750	M-90	217.874.439	✓	1
450	derecha	860	510	620/750	M-90	217.874.440	✓	1

- Para muebles esquina de rincón ciego
- Accede de forma sencilla a todos tus utensilios
- Herraje extraíble a la apertura de la puerta
- Cierro suave gracias a sus guías Soft Close
- Carga máxima de 25 kg, no recomienda sobrepasar los 6 kg por cesta



Cestas de varillas





23.07 magic corner reversible



minimo pt	cesto	ancho	fondo	alto	mueble		SK	
450	madera	660	455	595	M-90	217.874.533	✓	1
450	varilla	660	455	595	M-90	217.874.526	✓	1

secuencia apertura

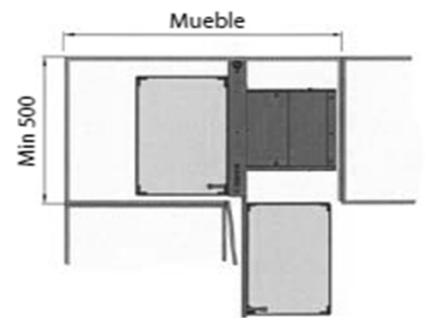
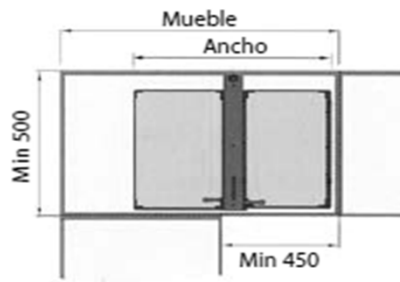

Válido izquierda y derecha

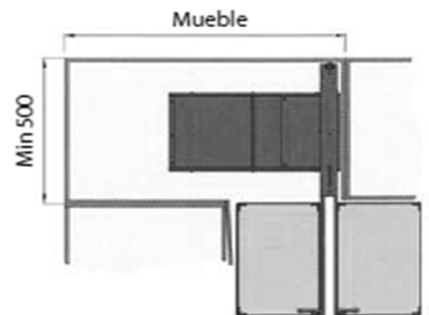
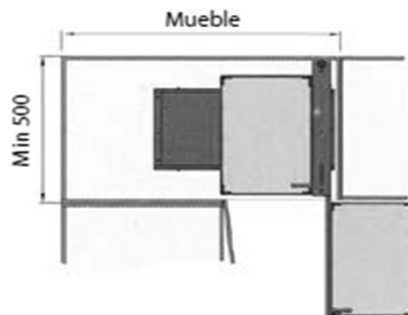



23.07

magic corner 40 reversible cesta varilla



min.pta	mano	fondo	alto	mueble	gris/brillo	SK	
400	<u>reversible</u>	490	620	M-90	217.811.484	✓	1

Altura mínima 620 mm. Carga dinámica de 8kg en cesta interna y 10 kg en cesta frontal. Incluye 4 cestas y sus herrajes.

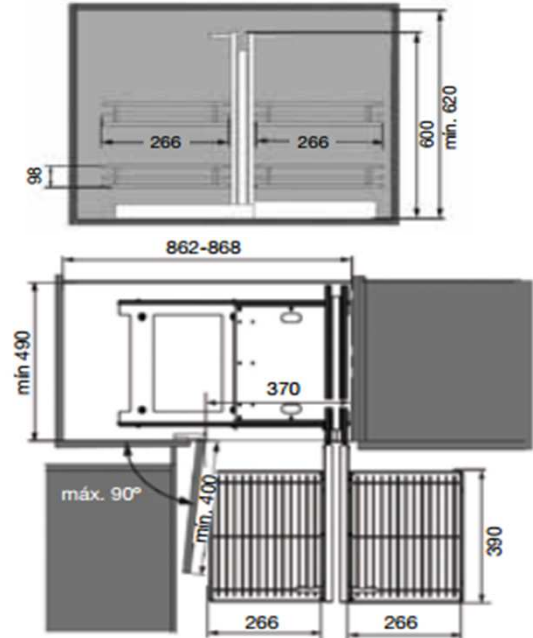

magic corner 40 reversible cesta madera



min.pta	mano	fondo	alto	mueble	gris/brillo	SK	
400	<u>reversible</u>	490	620	M-90	217.811.495	✓	1

Con base de melamina antideslizante. Altura mínima 620 mm. Sistema de cierre amortiguado. Extracción total de las cestas. Carga dinámica de 8kg por cesta. Incluye 4 cestas y sus herrajes

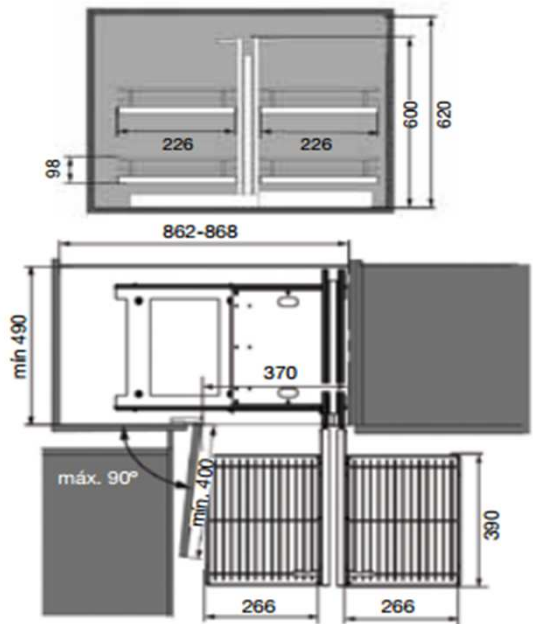

interiorismo cocina



89



23.07 magic corner 40 cesta varilla



mini.pta	mano	mueble	gris/brillo	SK	
400	izquierda	M-90	217.811.583	✓	1
400	derecha	M-90	217.811.594	✓	1

Con sistema de cierre amortiguado Carga dinámica de 9,5 kg en cesta interna y 8 kg en cesta frontal. Incluye 4 cestas y sus herrajes.

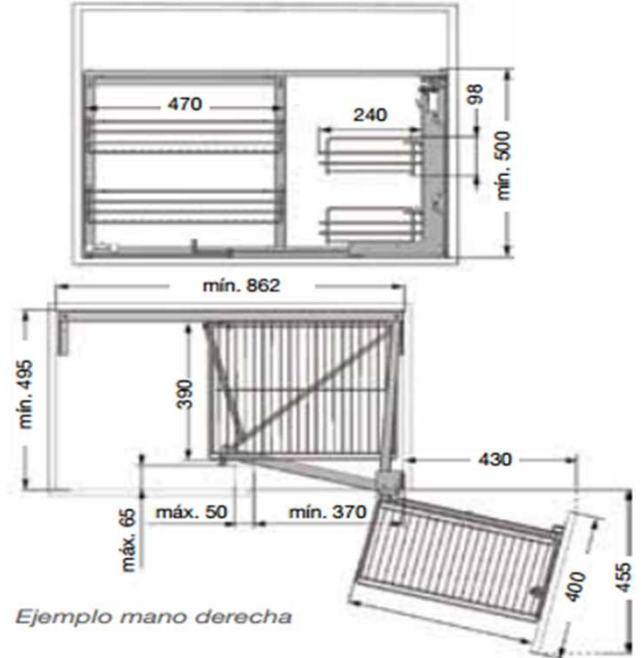

magic corner 40 cesta madera



mini.pta	mano	mueble	gris/brillo	SK	
400	izquierda	M-90	217.811.911	✓	1
400	derecha	M-90	217.811.922	✓	1

Con sistema de cierre amortiguado Carga dinámica de 9,5 kg en cesta interna y 8 kg en cesta frontal. Incluye 4 cestas y sus herrajes.

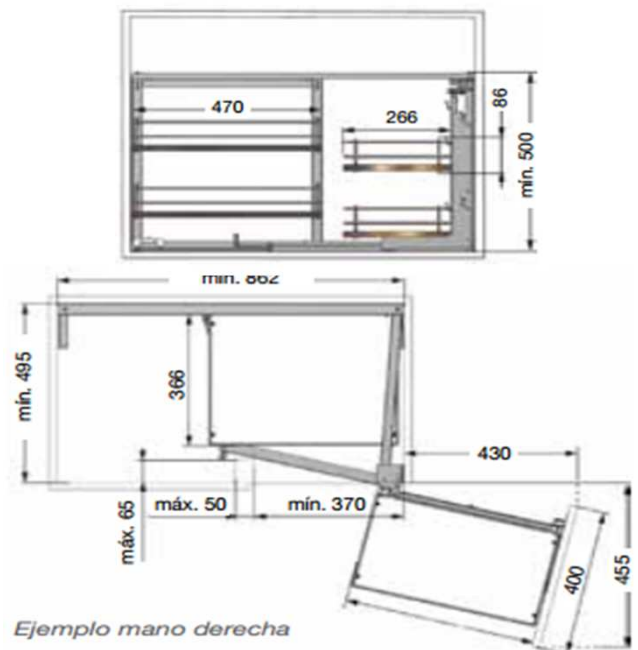



conjunto despensa CONVOY LAVIDO 120 KG



alto	cestas	mueble	gris	SK	
1900-2000	4	M-45	PEKCOLA45GR	✓	1
1900-2000	4	M-50	PEKCOLA50GR	✓	1
1900-2000	4	M-60	PEKCOLA60GR	✓	1

accesorio	mueble	gris	SK	
alfombrilla antideslizante estandar	M-45	100.076.418	✓	1
alfombrilla antideslizante estandar	M-50	100.076.518	✓	1
alfombrilla antideslizante estandar	M-60	100.076.618	✓	1
alfombrilla antideslizante magnetica	M-45	100.076.156	✓	1
alfombrilla antideslizante magnetica	M-50	100.076.256	✓	1
alfombrilla antideslizante magnetica	M-60	100.076.356	✓	1
divisor magnetico gris simple		200.070.652	✓	1
divisor magnetico gris 382 mm	M-45	200.147.012	✓	1
divisor magnetico gris 432 mm	M-50	200.147.212	✓	1
divisor magnetico gris 532 mm	M-60	200.147.612	✓	1



divisor magnetico



divisor magnetico simple



alfombrilla estandar

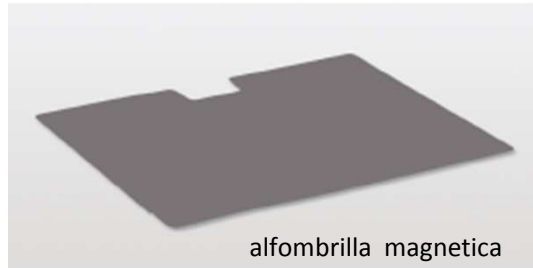

alfombrilla magnetica



**23.08** columna extraible CONVOY 120 KG

cestas	alto	mueble	blanco	gris	SK	
4	1200-1600	M-30	PEKCOLB1230	PEKCOLG1230	✓	1
4	1200-1600	M-40	PEKCOLB1240	PEKCOLG1240	✓	1
4	1200-1600	M-45	PEKCOLB1245	PEKCOLG1245	✓	1
4	1200-1600	M-50	PEKCOLB1250	PEKCOLG1250	✓	1
4	1200-1600	M-60	PEKCOLB1260	PEKCOLG1260	✓	1
5	1600-2000	M-30	PEKCOLB1630	PEKCOLG1630	✓	1
5	1600-2000	M-40	PEKCOLB1640	PEKCOLG1640	✓	1
5	1600-2000	M-45	PEKCOLB1645	PEKCOLG1645	✓	1
5	1600-2000	M-50	PEKCOLB1650	PEKCOLG1650	✓	1
5	1600-2000	M-60	PEKCOLB1660	PEKCOLG1660	✓	1
6	1800-2260	M-30	PEKCOLB1930	PEKCOLG1930	✓	1
6	1800-2260	M-40	PEKCOLB1940	PEKCOLG1940	✓	1
6	1800-2260	M-45	PEKCOLB1945	PEKCOLG1945	✓	1
6	1800-2260	M-50	PEKCOLB1950	PEKCOLG1950	✓	1
6	1800-2260	M-60	PEKCOLB1960	PEKCOLG1960	✓	1

accesorios	mueble	blanco	gris	SK	
divisor magnetico simple		100.070.651	200.070.652	✓	1
divisor magnetico gris 382 mm	M-45		200.147.012	✓	1
divisor magnetico gris 432 mm	M-50		200.147.212	✓	1
divisor magnetico gris 532 mm	M-60		200.147.612	✓	1
alfombrilla antideslizante magnetica	M-30	100.069.957	100.069.956	✓	1
alfombrilla antideslizante magnetica	M-40	100.070.157	100.070.156	✓	1
alfombrilla antideslizante magnetica	M-45	100.070.257	200.070.256	✓	1
alfombrilla antideslizante magnetica	M-50	100.070.357	200.070.356	✓	1
alfombrilla antideslizante magnetica	M-60	100.070.557	200.070.556	✓	1
alfombrilla antideslizante estandar	M-30		100.072.618	✓	1
alfombrilla antideslizante estandar	M-40		100.072.818	✓	1
alfombrilla antideslizante estandar	M-45		100.072.918	✓	1
alfombrilla antideslizante estandar	M-50		100.0730.18	✓	1
alfombrilla antideslizante estandar	M-60		100.073.218	✓	1

columna extraible SWING giratoria 70 KG



cestas	alto	mueble	gris	SK	
6	2000-2200	M-30	PEKSWIN203G	✓	1
6	2000-2200	M-40	PEKSWIN204G	✓	1
6	2000-2200	M-45	PEKSWIN245G	✓	1



Validos los accesorios del modelo columna CONVOY.



conjunto despensa PLENO 80 KG ECO



cestas	alto	mueble	gris	antracita	SK	
4	1300	M-45	100.083.212	100.083.243	✓	1
4	1300	M-60	100.084.112	100.084.143	✓	1
4	1600	M-45	100.083.312	100.083.343	✓	1
4	1600	M-60	100.08.212	100.084.243	✓	1
4	1900	M-45	100.083.412	100.083.443	✓	1
4	1900	M-60	100.084.312	100.084.343	✓	1



accesorio	mueble	gris	SK	
alfombrilla antideslizante estandar	M-45	100.081.618	✓	1
alfombrilla antideslizante estandar	M-60	100.081.918	✓	1
alfombrilla antideslizante magnetica	M-45	100.081.256	✓	1
alfombrilla antideslizante magnetica	M-50	100.081.556	✓	1
divisor magnetico gris simple		200.070.652	✓	1
AMORTIGUADOR		100.040.904	✓	1

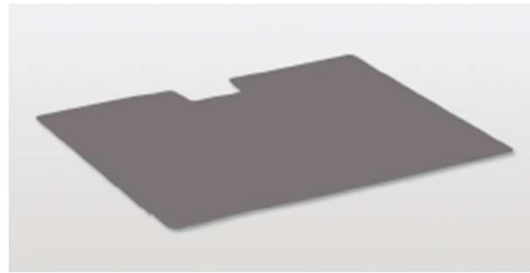

juego guia HOCHSCHRANK BOX columna madera



peso	fondo		SK	
150	490	100.009.201	✓	1
120	900	100.009.804	✓	1

ideal para la fabrica cion de modulos de carga extensibles en laminado.





23.08 cajon EXTENDO con adaptador guia oculta 30 KG



estante regulable magnetico



riel divisor magnetico



divisor magnetico simple



guias	marca	mueble	blanco	gris	SK	
si	V6 hettich	M-45	PEKEXTE45BL	PEKEXTE45GR	✓	1
si	V6 hettich	M-60	PEKEXTE60BL	PEKEXTE60GR	✓	1
si	V6 hettich	M-90	PEKEXTE90BL	PEKEXTE90GR	✓	1
si	V6 hettich	M-1200	PEKEXTE12BL	PEKEXTE12GR	✓	1
no		M-45	200.131.101	200.131.112	✓	1
no		M-60	200.131.701	200.131.712	✓	1
no		M-90	200.131.301	200.131.312	✓	1
no		M-1200	200.132.901	200.13.912	✓	1

se puede acoplar cualquier guia oculta del mercado en el modelo sin guia. , al aumentar la calidad de la guia sube el potencial en kgs

accesorios	blanco	gris	SK	
estante mag. Regulable 600	200.144.901	200.144.912	✓	1
estante mag. Regulable 900	200.145.501	200.145.512	✓	1
riel divisor magnetico 382 mm	200.147.001	200.147.012	✓	1
riel divisor magnetico 432 mm	200.147.201	200.147.212	✓	1
riel divisor magnetico 832 mm	200.147.601	200.147.612	✓	1
riel divisor magnetico 832 mm	200.148.201	200.148.212	✓	1
riel divisor magnetico 1132 mm	200.148.801	200.148.812	✓	1
alfombrilla antideslizante magnetica 450	200.136.557	200.136.556	✓	1
alfombrilla antideslizante magnetica 600	200.128.057	200.128.056	✓	1
alfombrilla antideslizante magnetica 900	200.128.157	200.128.156	✓	1
alfombrilla antideslizante magnetica 1200	200.138.157	200.138.156	✓	1
alfombrilla antideslizante estandar 450		200.135.018	✓	1
alfombrilla antideslizante estandar 600		200.135.318	✓	1
alfombrilla antideslizante estandar 900		200.135.618	✓	1
alfombrilla antideslizante estandar 1200		200.135.918	✓	1
divisor magnetico simple	100.070.651	200.070.652	✓	1



interiorismo cocina



d



23.08

botellero extraible SNELLO 15 KG

cestas	mueble	blanco	gris	SK	
2	M-15	200.127.201	200.127.212	✓	1
2	M-20	200.127.501	200.127.512	✓	1
2	M-30	200.128.301	200.128.312	✓	1

accesorios	blanco	gris	SK	
alfombrilla antideslizante magnetica 150	200.127.757	200.127.756	✓	1
alfombrilla antideslizante magnetica 200	200.127.857	200.127.856	✓	1
alfombrilla antideslizante magnetica 300	200.127.957	200.127.956	✓	1
alfombrilla antideslizante estandar 150		200.133.118	✓	1
alfombrilla antideslizante estandar 200		200.133.218	✓	1
alfombrilla antideslizante estandar 300		200.133.318	✓	1
divisor magnetico simple	100.070.651	200.070.652	✓	1



desmontable los cestos

conjunto extraible SLIM 30 KG

cestas	mueble	gris	SK	
3	M-40	PEKSLIM400G	✓	1
3	M-45	PEKSLIM450G	✓	1

accesorios	gris	SK	
alfombrilla antideslizante magnetica 400	300.068.556	✓	1
alfombrilla antideslizante magnetica 400	300.068.657	✓	1
alfombrilla antideslizante estandar 400	300.091.418	✓	1
alfombrilla antideslizante estandar 450	300.091.518	✓	1



interiorismo cocina



e



23.08

extraible organizador TOWER KITCHEN



mueble	blanco	gris	SK	
M-45	200.160.021	200.160.012	✓	1
M-60	200.160.121	200.160.112	✓	1



magic corner CONFORT



minimo pt:	mano	B	T	H	mueble	blanco	SK	
450	derecha	660/971	500 min	545 min	M-90	PEKMCCOD45B	✓	1
450	izquierda	660/971	500 min	545 min	M-90	PEKMCCOI45B	✓	1

minimo pt:	mano	B	T	H	mueble	gris	SK	
450	derecha	660/971	500 min	545 min	M-90	PEKMCCOD45G	✓	1
450	izquierda	660/971	500 min	545 min	M-90	PEKMCCOI45G	✓	1



minimo pt:	mano	B	T	H	mueble	antracita	SK	
450	derecha	660/971	500 min	545 min	M-90	PEKMCCOD45A	✓	1
450	izquierda	660/971	500 min	545 min	M-90	PEKMCCOI45A	✓	1

set alfombrillas magneticas gris

blanco	gris	SK	
300.068.157	300.068.156	✓	1
	300.092.318	✓	1

set alfombrillas estandar gris

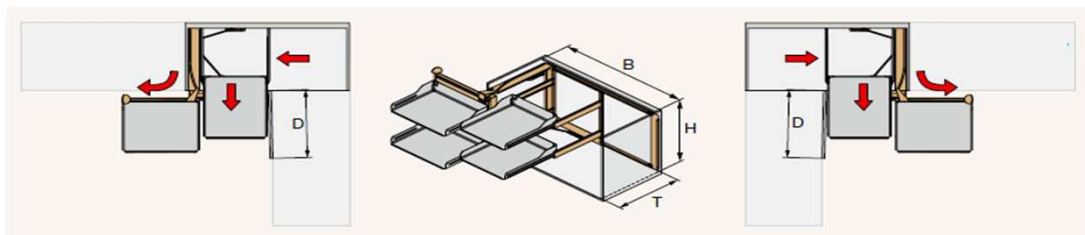

izquierda

derecha

interiorismo cocina



f

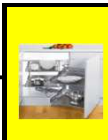

magic corner FLEX puerta 40



minimo pl	mano	B	T	H	mueble	blanco	SK	
400	derecha	860/971	500 min	525 min	M-90	PEKMCFLD40B	✓	1
400	izquierda	860/971	500 min	525 min	M-90	PEKMCFLI40B	✓	1

minimo pl	mano	B	T	H	mueble	gris	SK	
400	derecha	660/971	500 min	545 min	M-90	PEKMCFLD40B	✓	1
400	izquierda	660/971	500 min	545 min	M-90	PEKMCFLI40B	✓	1

blanco	gris	SK	
--------	------	----	--

set alfombrillas magneticas gris	300.068.057	300.068.056	✓	1
set alfombrillas estandar gris		300.092.218	✓	1
divisor magnetico simple	100.070.651	200.070.652	✓	1

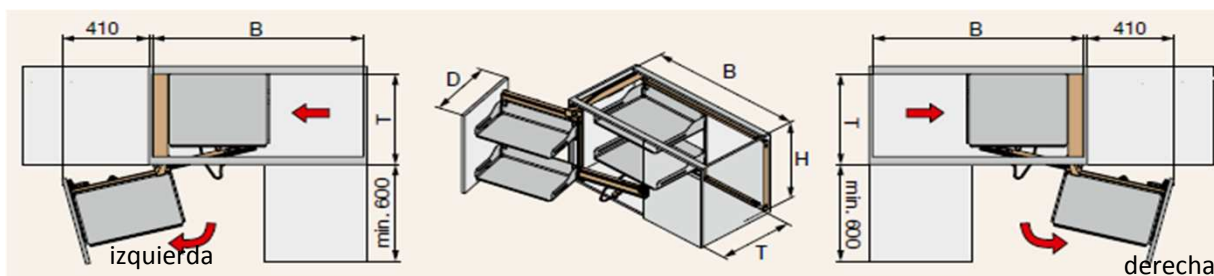

sistema PEGASUS regulable hasta 12 KG

cestas	mueble	blanco	gris	SK		
4	677-980 mm	M-90	PEKPEGA90BL	PEKPEGA90BL	✓	1
set alfombrilla antideslizante magnetica		500.021.957	500.021.956	✓	1	
divisor magnetico simple		100.070.651	200.070.652	✓	1	



23.08 kit cajon zocalo INTRA

PLASTICO

fondo	blanco	SK	
450	610.811.763	✓	1

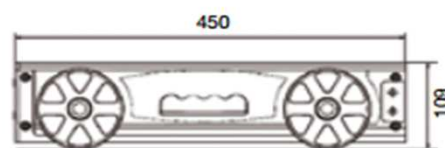

No incluye base ni trasera.

Las grapas vienen preparadas para pata redonda.
En otros tipos de pata se puede instalar fijando el perfil
guía con silicona en el suelo.





23.09

peka
ergonomic storage features

cubo reciclaje MÜLLBOY



alto	lts	mod.	mueble	blanco	SK	
500mm	30	1	M-45	200.004.301	✓	1
430 mm	25	2	M-45	200.004.701	✓	1

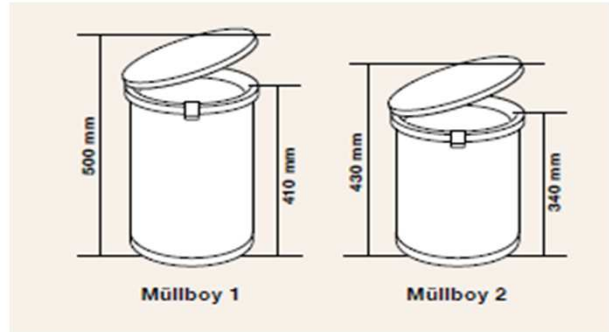

cubo reciclaje EXTRAIBLE S+R5145

peka
ergonomic storage features



alto	lts	mueble	SK	
470mm	1x35+2x3	M-45	200.122.312	✓



cubo reciclaje EXTRAIBLE S+R5045

peka
ergonomic storage features



alto	lts	mueble	SK	
470mm	1x35+1x4,5+1x2,5+3x3	M-60	200.122.812	✓



interiorismo cocina



a



23.09 cubo reciclaje ABATIBLE PESABOY 450



alto	lts	mueble	SK	
515mm	1x35	M-45	200.089.302	✓ 1



cubo reciclaje ABATIBLE PESABOY 600



alto	lts	mueble	SK	
405mm	1x26+1X4,5	M-60	200.121.612	✓ 1



accesorio PEDAL para cubos S+R abre facil



SK	
200.1140.100	✓ 1

interiorismo cocina



b

accesorio pedal para cubos S+R , tambien se puede adaptar para la apertura de cualquier elemento extraible en modulo bajo.



cubos reciclaje TRACK informacion



Válido para la mayoría de marcas.

Este accesorio se instala sobre cajones metálicos de extracción total.



Práctico y versátil.

Deposita los residuos directamente de la encimera al cubo ahorrando tiempo.



Embellecedor y fijación de bolsa.

La bolsa queda oculta gracias a un embellecedor, fácil de colocar y fácil de limpiar. Válido para el uso con bolsas de basura estándar.

Tapa antiolores.

Tu cocina libre de olores. Los cubos incorporan una tapa plástica extraíble, que permanece oculta y que se ajusta a los cubos una vez cerrados. La tapa se extrae fácilmente para su limpieza.

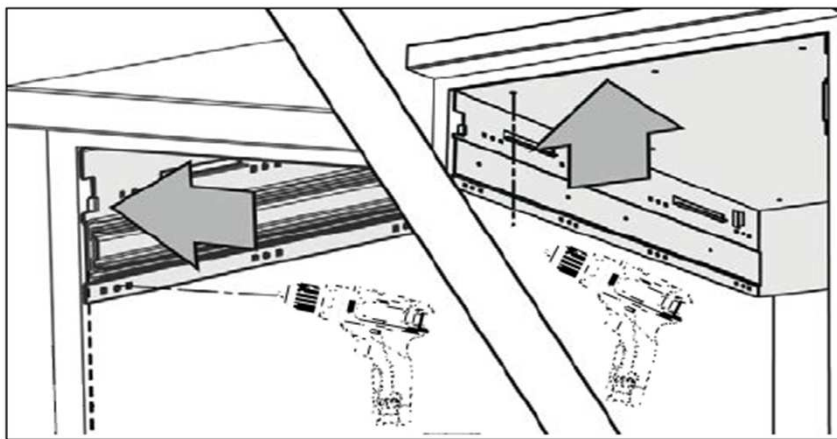

Dos formas de instalación.

El herraje se puede fijar tanto a la tapa superior del módulo, como a su lateral.

Este herraje se puede instalar en módulos de 16, 18 o 19 mm.

¿Qué incluye en este producto?

¿Qué necesitas para su instalación?

El producto incluye la estructura interior metálica, la tapa antiolores, tornillos, adaptadores y los cubos.

Para completar su instalación, necesitas un cajón metálico de extracción total soft close.





23.09 cubo reciclaje sobre cajon soft close TRACK 26 L



medidas	lts	mueble	gris	SK	
362x513x333	2x13	M-40	211.874.052	✓	1

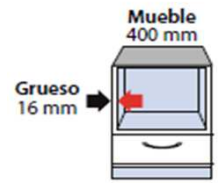
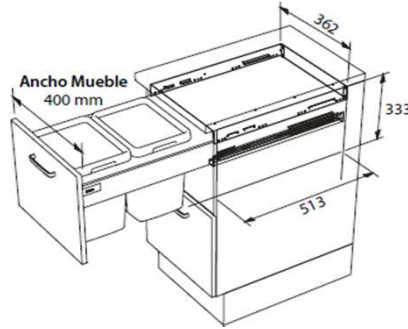

cubo reciclaje sobre cajon soft close TRACK 36 L



medidas	lts	mueble	gris	SK	
362x513x463	2x18	M-40	211.874.053	✓	1

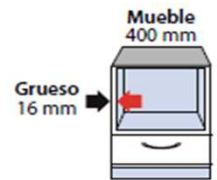
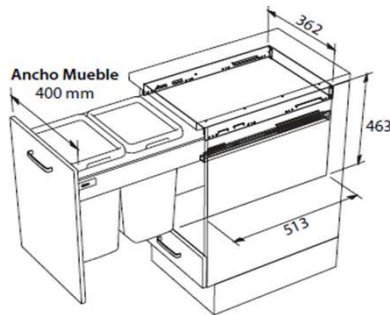

cubo reciclaje sobre cajon soft close TRACK 35 L



medidas	lts	mueble	gris	SK	
362x413x563	1x35	M-40	211.874.054	✓	1

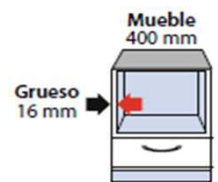
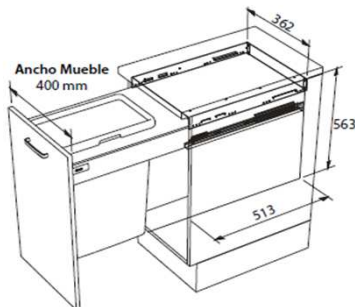



23.09

cubo reciclaje sobre cajon soft close TRACK 70 L



medidas	lts	mueble	gris	SK	
562x513x563	2x35	M-60	211.874.055	✓	1

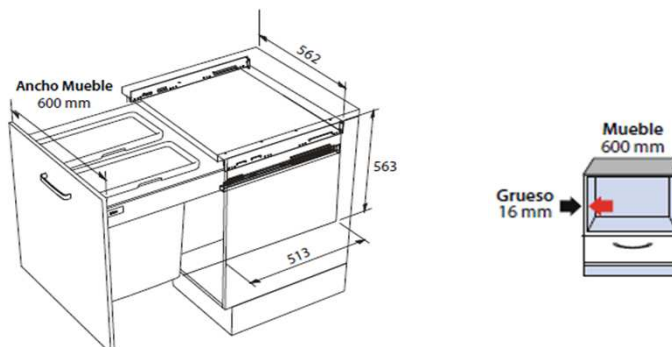

cubo reciclaje CLASS 30 L



medidas	lts	mueble	gris	SK	
340x510x330	2x15	M-40	211.874.056	✓	1

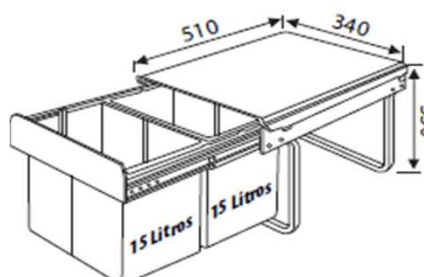

cubo reciclaje CLASS 40 L



medidas	lts	mueble	gris	SK	
340x549x430	2x20	M-40	211.874.057	✓	1

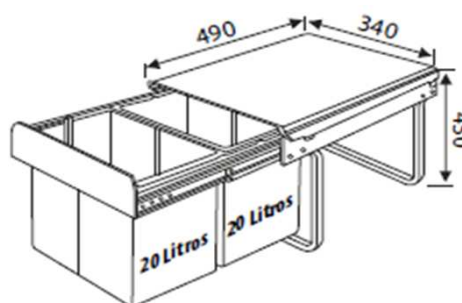



23.09 cubo reciclaje CLASS 40 L PLUS

medidas	lts	mueble	gris	SK	
340x510x430	2x10+1x20	M-40	211.874.058	✓	1

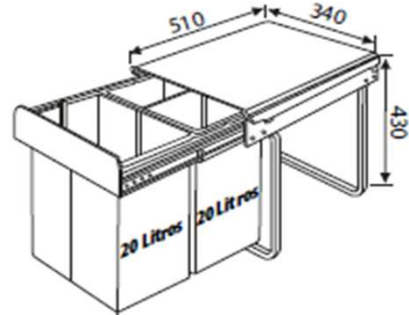

cubo reciclaje ALDO



anch/alt/fond	lts	mueble	gris	SK	
343x372x475	2x16	M-45	211.811.305	✓	1
343x372x475	1x16+2x7,5	M-45	211.811.316	✓	1



Permite 2 instalaciones:
 con o sin extracción del cubo al abrir la puerta
 Bandeja superior porta objetos
 Base mínima de 400 mm.
 Sistema de cierre amortiguado
 Sin necesidad de extraer el contenedor
 podemos abrir la tapa frontal





23.09

cubo reciclaje ALDO inox



anch/alt/fond	lts	mueble	gris	SK	
343x372x475	2x16	M-45	211.811.320	✓	1
343x372x475	1x16+2x7,5	M-45	211.811.331	✓	1



Sin necesidad de extraer el contenedor podemos abrir la tapa frontal



Permite 2 instalaciones:
 con o sin extracción del cubo al abrir la puerta
Bandeja superior porta objetos
Base mínima de 400 mm.
Sistema de cierre amortiguado
 Sin necesidad de extraer el contenedor
 podemos abrir la tapa frontal

cubo reciclaje con pedal JERKO libre colocacion

ACERO INOX/POLIPROPILENO

anch/alt/fond	lts	acero inox	SK	
410x485x340	2x15	211.811.813	✓	1
605x485x340	3x15	211.811.824	✓	1



15 + 15 litros



15 + 15 + 15 litros

Destinados a la recogida selectiva de residuos domésticos. Disponibles con 2 y 3 compartimentos con cubetas de plástico removibles y con asas que facilitan su extracción y limpieza. Cada cubeta tiene una capacidad de 15 L. Permite identificar el tipo de residuo a depositar en cada cubeta mediante el color del pedal.





23.09 cubo reciclaje PIVO 13 L

ACERO INOX/PLASTICO



Inox Brillo



Blanco

mueble	lts	acabado		SK	
M-35	1X13	blanco	211.811.785	✓	1
M-35	1X13	acero inox	211.811.153	✓	1



cubo reciclaje PIVO 25 L



anch/alt/fond	lts	mueble	inox brillo	SK	
340x345x355	1X25	M-40	211.811.960	✓	1

cubo reciclaje ELIO 16 L



anch/alt/fond	lts	acabado		SK	
320x360x380	1X16	inox brillo	211.811.386	✓	1
320x360x380	1X16	gris	211.811.364	✓	1

Apertura automática de la tapa al extraer el cubo del mueble.
Base mínima de 300 mm.





23.09

cubo reciclaje embutir encimera ZARAUTZ 9 L



tapa	alto	d:cubo	d:encastre	acero inox	SK	
270	260	195	237	211.811.864	✓	1

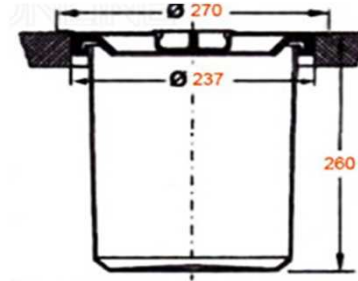

Capacidad 9L

kit cajon cubo reciclaje PLUS



cubos	mueble		SK	
2 unidades	M-60	239.811.800	✓	1
3 unidades	M-80	239.811.811	✓	1
3 unidades	M-90	239.811.822	✓	1



Con sistema de cierre amortiguado "SOFT BRAKE". **Tapa de apertura automática.** Guías correderas de bolas de acero, extracción total. Carga dinámica 30 kg. hasta mueble de 60 y para muebles de 80 a 120, carga de 50 kg. Incluye cesto y juego de guías. Adaptable para módulos de 16/18/19 mm. de grosor. Fondo interior mínimo de mueble 500 mm. El kit esta formado por todos los accesorios necesarios

kit cajon cubo reciclaje PLUS ECO

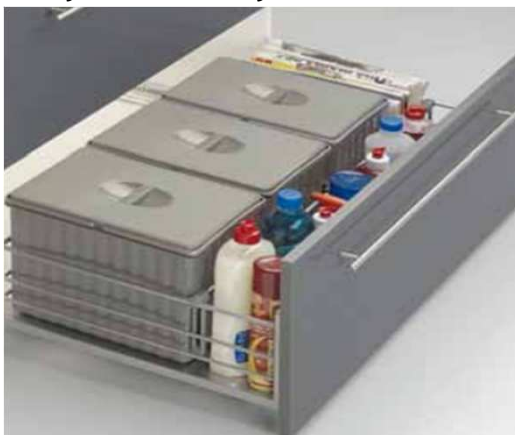

cubos	mueble		SK	
2 unidades	M-60	239.811.741	✓	1
3 unidades	M-80	239.811.752	✓	1
3 unidades	M-90	239.811.763	✓	1



Con sistema de cierre amortiguado "SOFT BRAKE". Guías correderas de bolas de acero, extracción total. Carga dinámica 30 kg. hasta mueble de 60 y para muebles de 80 a 120, carga de 50 kg. Incluye cesto y juego de guías. Adaptable para módulos de 16/18/19 mm. de grosor. Fondo interior mínimo de mueble 500 mm. El kit esta formado por todos los accesorios necesarios





23.09 KIT CAJON cubo reciclaje COMPAC



cubos	mueble		SK	
2 unidades	M-60	239.811.106	✓	1
3 unidades	M-80	239.811.110	✓	1
3 unidades	M-90	239.811.121	✓	1

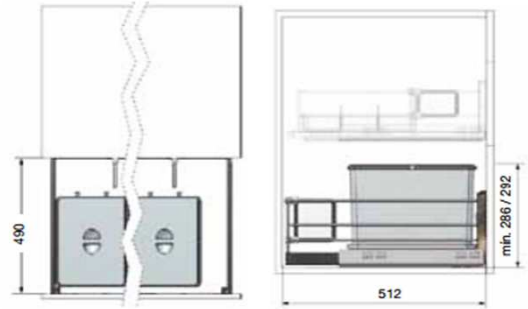

Con sistema de cierre amortiguado "SOFT BRAKE".
 Con base de melamina antideslizante. Guías correderas de bolas de acero, extracción total. Carga dinámica 30/50 kg.
 Adaptable para módulos de 16/18/19 mm. de grosor.

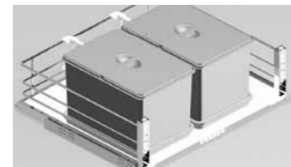

cubo reciclaje DIVER\$ para cajon



ancho	alto	fondo	capacidad	gris claro	SK	
33	32	47	16x2 litros	239.811.486	✓	1
33	32	47	16x1+2x7,5 litros	239.811.490	✓	1

Apertura simultánea de tapa y cajón.

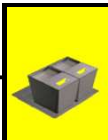

cubo reciclaje PREMIER para cajon

Para M-60

16 + 16 Litros

Ancho: mín 454 / máx 540

Alto: 295

Fondo: 490

cubos	mueble	blanco-inox	antracita-inox	SK	
2 unidades	M-60	239.811.474	239.811.485	✓	1
3 unidades	M-80	239.811.496	239.811.500	✓	1
3 unidades	M-90	239.811.511	239.811.522	✓	1
4 unidades	M-120	239.811.533	239.811.544	✓	1
elemento para papel(opcional)		239.811.555	239.811.905	✓	1



Los contenedores disponen de asa para colocarlos y retirarlos fácilmente. La tapa, en acero inoxidable, dispone de bisagras para facilitar el enganche o desenganche de la bolsa, dejándola oculta en su interior.

Para M-80

16 + 16 + 16 Litros

Ancho: mín 690 / máx 740

Alto: 295

Fondo: 490



*Elemento para papel:
Ideal para reciclaje de
revistas, periódicos, etc.*

Para M-90

16 + 16 + 16 Litros

Ancho: mín 790 / máx 840

Alto: 295

Fondo: 490

Para M-120

16 + 16 + 16 + 16 Litros

 Con elemento para papel
instalado (opcional)

Ancho: mín 1018 / máx 1140

Alto: 295

Fondo: 490



23.09

cubo reciclaje BOX para cajon de 60 cms



mueble		SK	
M-60	239.811.321	✓	1

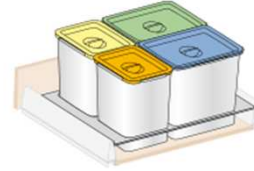

Contenido:
2 cubos de 16 Lts.
2 cubos de 8 Lts.
Soporte base.

cubo reciclaje BOX para cajon de 80 cms



mueble		SK	
M-80	239.811.332	✓	1

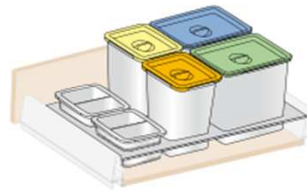

Contenido:
2 cubos de 16 Lts.
2 cubos de 8 Lts.
2 recipientes.
Soporte base.

cubo reciclaje BOX para cajon de 90 cms



mueble		SK	
M-90	239.811.343	✓	1

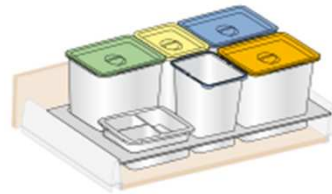

Contenido:
3 cubos de 16 Lts.
2 cubos de 8 Lts.
1 recipiente.
Soporte base.

cubo reciclaje BOX para cajon de 120 cms



mueble		SK	
M-120	239.811.365	✓	1

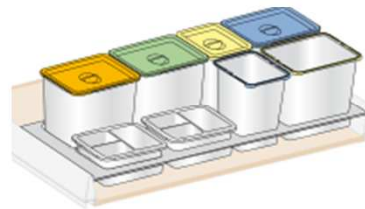

Contenido:
4 cubos de 16 Lts.
2 cubos de 8 Lts.
2 recipientes.
Soporte base.

recambio cubo reciclaje BOX para cajon

litros	tapa amarilla	tapa naranja	tapa verde	tapa azul	SK	
8	239.811.376	239.811.380	239.811.391	239.811.402	✓	1
16	239.811.413	239.811.424	239.811.435	239.811.446	✓	1



interiorismo cocina



1

p= bajo pedido

✓= stock