

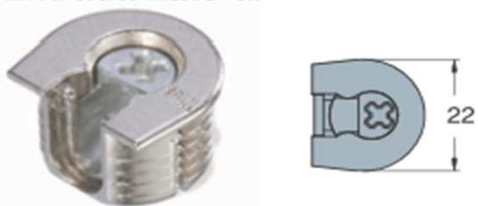

Titus+

Side-entry **excentrico**
Entrada Lateral



Referencia	e	B	D	item	Acabado	SK
412.334.451	8	15/16	12,5	06451	zinc	✓
412.233.431	9,5	18/19	14	06453	zinc	✓

Embalaje 500 unid.

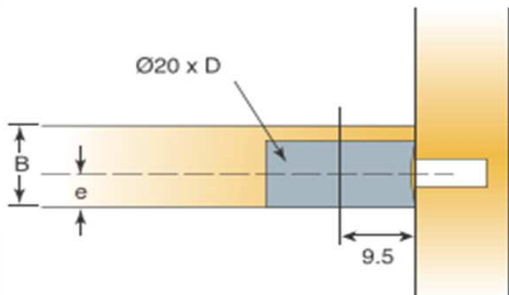

Titus+

Drop-on **excentrico**
Entrada Vertical



Referencia	e	B	D	item	Acabado	SK
412.334.447	8	15/16	12,5	06447	zinc	✓
412.233.449	9,5	18/19	14	06449	zinc	✓

Embalaje 500 unid.

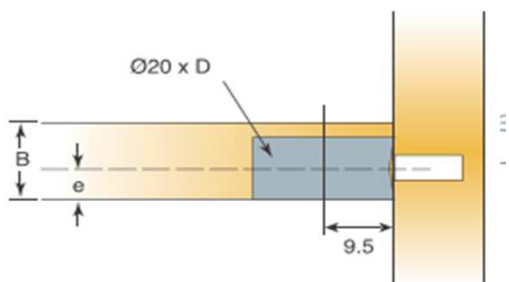

Titus+

Side-entry **excentrico**
Entrada Lateral



Referencia	e	B	D	item	Acabado	SK
412.334.455	8	15/16	12,5	06459	zinc	✓
412.334.459	9,5	18/19	14	06461	zinc	✓

Embalaje 500 unid.

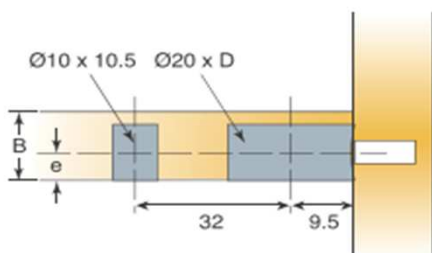

Disponible
Consultar



Titus+

Drop-on **excentrico**
Entrada Vertical

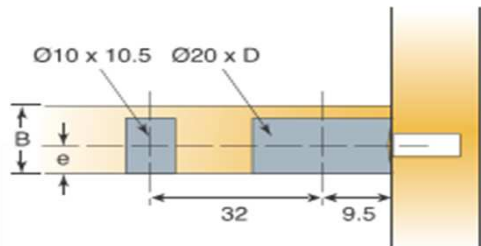
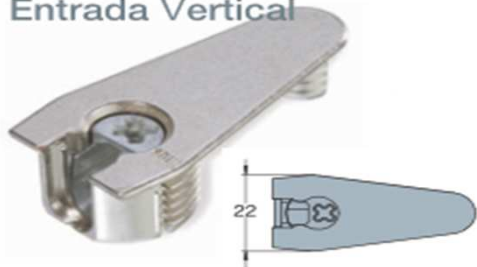

Referencia	e	B	D	item	Acabado	SK
412.334.456	8	15/16	12,5	06455	zinc	✓
412.233.442	9,5	18/19	14	06457	zinc	✓

Embalaje 500 unid.

Titus+

Side-entry **golpe**
Entrada Lateral

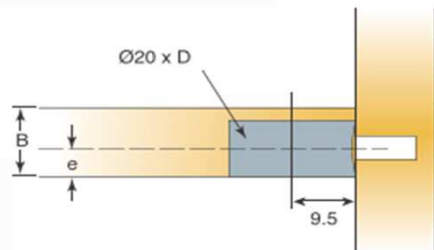
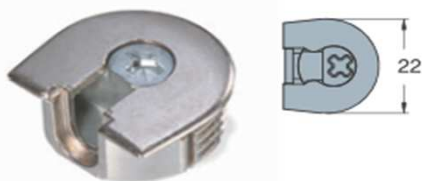

Referencia	e	B	D	item	Acabado	SK
412.334.581	8	15/16	12,5	9581	zinc	✓
412.233.580	9,5	18/19	14	9580	zinc	✓

Embalaje 500 unid.

No aptos para pernos Expando

Titus+

Drop-on **golpe**
Entrada Vertical

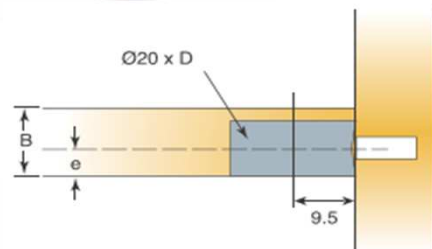
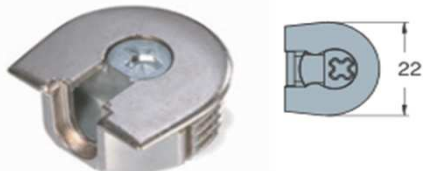

Referencia	e	B	D	item	Acabado	SK
412.334.494	8	15/16	12,5	9494	zinc	✓
412.334.493	9,5	18/19	14	9493	zinc	✓

Embalaje 500 unid.

No aptos para pernos Expando



Disponible

Consultar



Titus+

Side-entry
Entrada Lateral

golpe

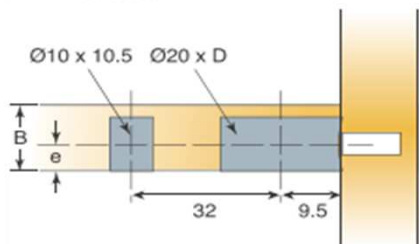
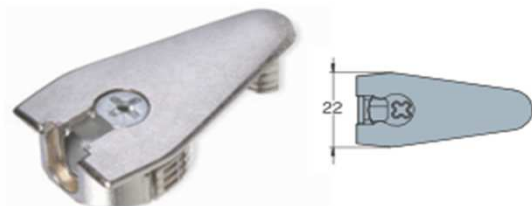

Referencia	e	B	D	item	Acabado	SK
412.334.579	8	15/16	12,5	9579	zinc	✓
412.233.573	9,5	18/19	14	9573	zinc	✓

Embalaje 500 unid.

No aptos para pernos Expando

Titus+

Drop-on
Entrada Vertical

golpe

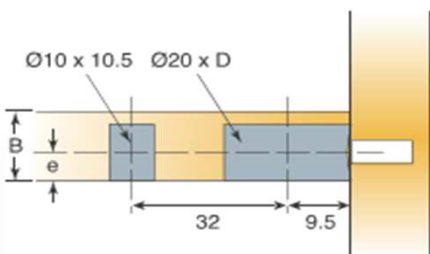
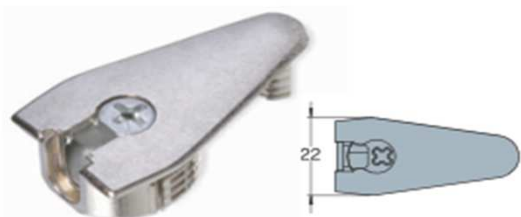

Referencia	e	B	D	item	Acabado	SK
412.334.496	8	15/16	12,5	9496	zinc	✓
412.233.495	9,5	18/19	14	9495	zinc	✓

Embalaje 500 unid.

No aptos para pernos Expando

Titus+

Side-entry
Entrada Lateral

excentrico

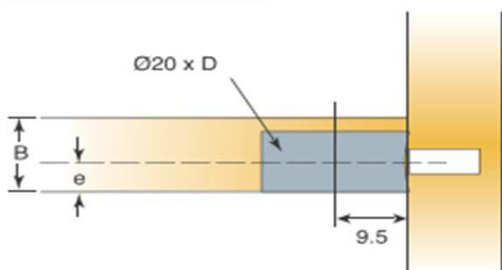

Referencia	e	B	D	item	Acabado	SK
412.334.438	8	15/16	12,5	6435	blanco	
412.334.437	9,5	18/19	14	6437	blanco	
412.334.441	8	15/16	12,5	6435	negro	
412.334.442	9,5	18/19	14	6437	negro	
412.334.386	8	15/16	12,5	6435	gris	✓
412.334.387	9,5	18/19	14	6437	gris	✓
412.334.431	8	15/16	12,5	6435	marron	
412.334.432	9,5	18/19	14	6437	marron	

Embalaje 2500 unid.



Disponible

Consultar



Titus+

Drop-on
Entrada Vertical

excentrico

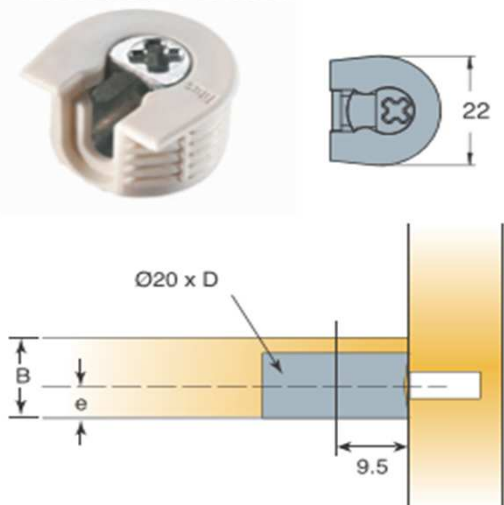

Referencia	e	B	D	item	Acabado	SK
412.334.428	8	15/16	12,5	6431	blanco	
412.334.427	9,5	18/19	14	6433	blanco	
412.334.431	8	15/16	12,5	6431	negro	
412.334.432	9,5	18/19	14	6433	negro	
412.334.383	8	15/16	12,5	6431	gris	
412.334.438	9,5	18/19	14	6433	gris	
412.334.421	8	15/16	12,5	6431	marron	
412.334.422	9,5	18/19	14	6433	marron	

Embalaje 2500 unid.

Titus+

Side-entry
Entrada Lateral

excentrico

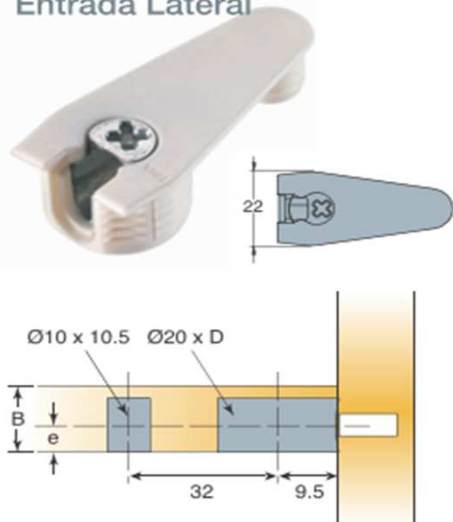

Referencia	e	B	D	item	Acabado	SK
412.334.429	8	15/16	12,5	6443	blanco	
412.334.428	9,5	18/19	14	6445	blanco	
412.334.433	8	15/16	12,5	6443	negro	
412.334.434	9,5	18/19	14	6445	negro	
412.334.461	8	15/16	12,5	6443	gris	
412.334.445	9,5	18/19	14	6445	gris	
412.334.420	8	15/16	12,5	6443	marron	
412.334.423	9,5	18/19	14	6445	marron	

Embalaje 1250 unid.

Titus+

Drop-on
Entrada Vertical

excentrico

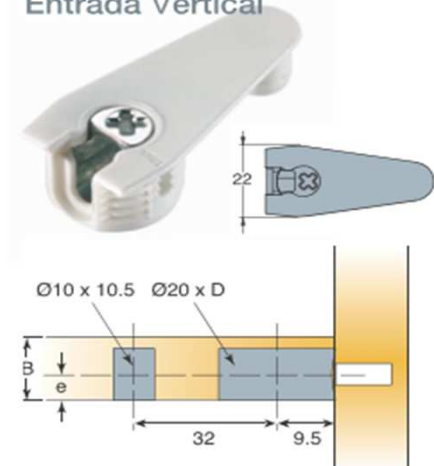

Referencia	e	B	D	item	Acabado	SK
412.334.440	8	15/16	12,5	6439	blanco	
412.334.448	9,5	18/19	14	6441	blanco	
412.334.447	8	15/16	12,5	6439	negro	
412.334.444	9,5	18/19	14	6441	negro	
412.334.443	8	15/16	12,5	6439	gris	
412.334.457	9,5	18/19	14	6441	gris	
41.233.451	8	15/16	12,5	6439	marron	
412.334.413	9,5	18/19	14	6441	marron	

Embalaje 1250 unid.



Disponible

Consultar



Titus+

Uso exclusivo con pernos dowels

standard

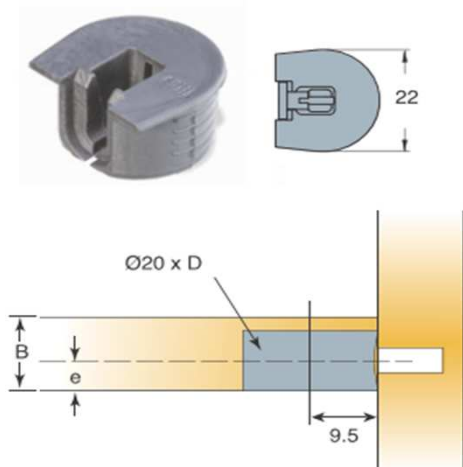

Referencia	e	B	D	item	Acabado	SK
412.334.470	6	12	10	06470	gris	
412.233.476	8	15/16	12,5	06473	gris	
412.334.465	9,5	18/19	14	06465	gris	
412.233.464	11	22	16	06464	gris	
412.334.481	6	12	10	06470	blanco	
412.233.486	8	15/16	12,5	06473	blanco	
412.334.466	9,5	18/19	14	06465	blanco	
412.233.474	8	15/16	12,5	06473	negro	
412.334.491	9,5	18/19	14	06465	negro	
412.233.499	8	15/16	12,5	06473	marron	
412.334.403	9,5	18/19	14	06465	marron	

Titus+

Uso exclusivo con pernos Quickfit dowels

expandible

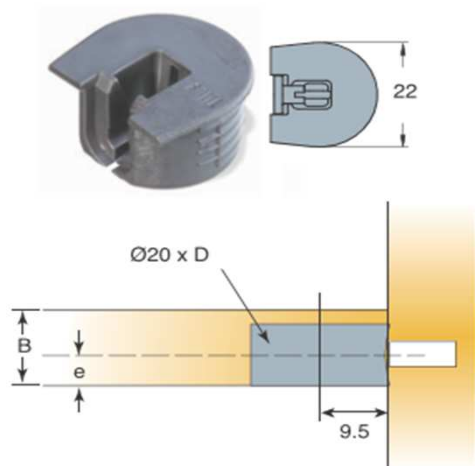

Embalaje 2500 unid.

No aptos para pernos quickfit

Referencia	e	B	D	item	Acabado	SK
412.334.471	8	15/16	12,5	06471	gris	
412.233.472	9,5	18/19	14	06472	gris	
412.334.404	8	15/16	12,5	06471	blanco	
412.233.415	9,5	18/19	14	06472	blanco	
412.334.406	8	15/16	12,5	06471	negro	
412.233.407	9,5	18/19	14	06472	negro	
412.334.418	8	15/16	12,5	06471	marron	
412.233.409	9,5	18/19	14	06472	marron	

Embalaje 2500 unid.

Titus+

Side-entry **entrada lateral golpe**

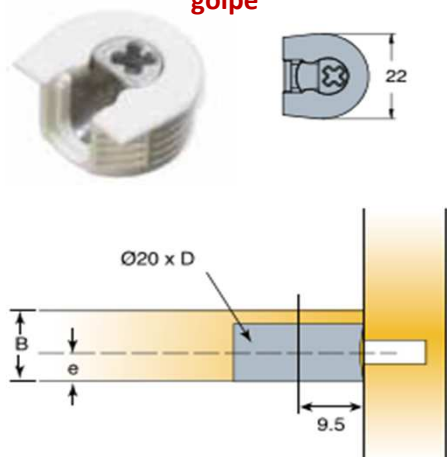

Referencia	B	D	item	Acabado	SK
412.334.181	15/16	12,5	06381	gris	
412.233.185	18/19	14	06385	gris	
412.334.182	15/16	12,5	06381	blanco	
412.233.186	18/19	14	06385	blanco	

Embalaje 2500 unid.



Disponible
Consultar







Titus+

Drop-on

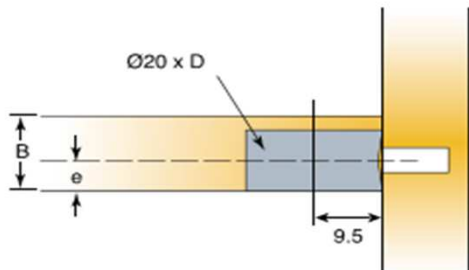
entrada superior

golpe



Referencia	B	D	item	Acabado	SK
412.334.183	15/16	12,5	06383	gris	
412.233.187	18/19	14	06387	gris	
412.334.184	15/16	12,5	06383	blanco	
412.233.188	18/19	14	06387	blanco	

Embalaje 2500 unid.





Titus+
Dowel
Quickfit



D2= Ø5mm



D2= Ø8mm

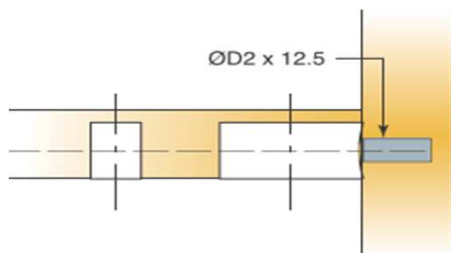

Titus+
Dowel Ø5 x 7.5
back-to-back
applications

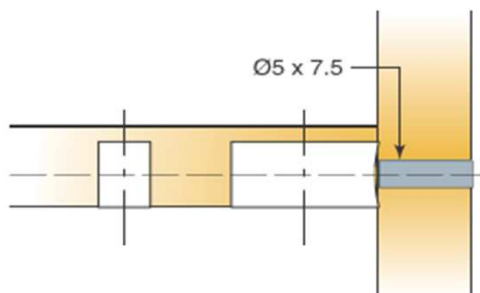

Titus+
Dowel Ø5

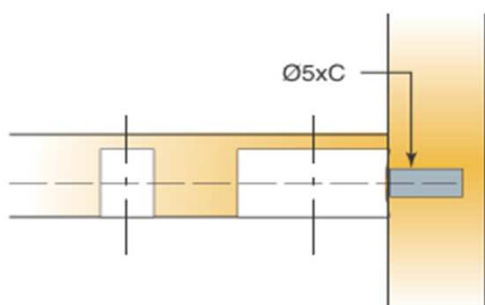

Referencia	D2	item	Acabado	SK
412.334.408	5	06408	gris	✓
412.233.410	8	06410	gris	⌚

Embalaje 5000 unid.

Referencia	D2	item	Acabado	SK
412.334.479	5	06479	gris	✓

Embalaje 5000 unid.

indicado especialmente para la colocacion de baldas

Referencia	C	item	Acabado	SK
412.334.401	9	06401	zinc	✓
412.334.402	8	06402	zinc	✓
412.334.480	11,5	06406	zinc	✓

Embalaje 2000 unid.



Disponible



Consultar



Titus+

Dowel M4 x 7

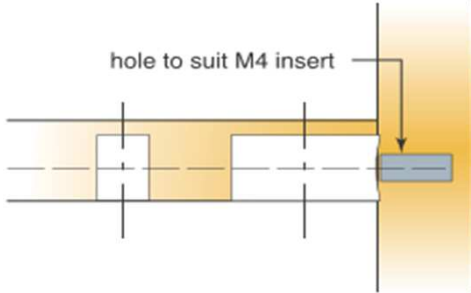

Referencia	D2	item	Acabado	SK
412.334.405	m4	06405	gris	✓

Embalaje 4500 unid.

Titus+

Dowel Ø3 x 11.5

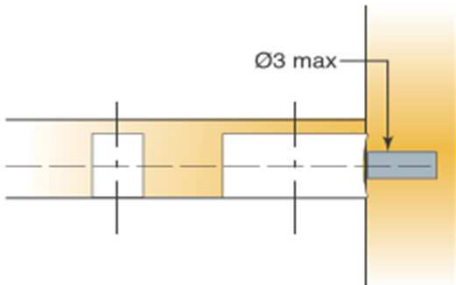

Referencia	D2	item	Acabado	SK
412.334.482	5	06495	gris	✓

Embalaje 12500 unid.

Titus+

Double-ended
dowel

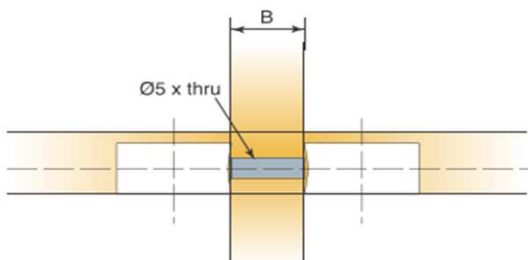
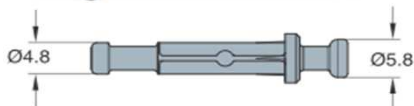

Referencia	B	item	Acabado	SK
412.334.644	16	06414	zinc	
412.334.643	18	06413	zinc	
412.334.646	19	06416	zinc	

Embalaje 2500 unid.



Disponible

Consultar



Titus+
End dowel

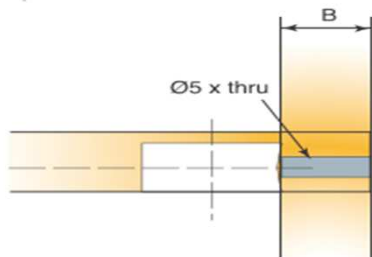
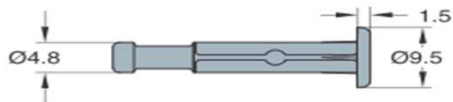

Referencia	D2	item	Acabado	SK
412.334.684	16	06412	zinc	
412.334.683	18	06411	zinc	
412.334.686	19	06415	zinc	

Embalaje 4500 unid.



Disponible
Consultar