

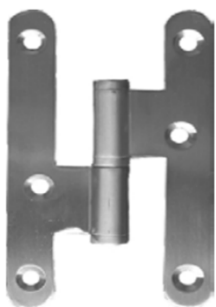

13.01

**pernio hierro sin remate 100x58x2,0**



mano	laton satinado	níquel satinado	SK	
derecha	521.131.080	521.131.090	✓	2/20
izquierda	521.131.081	521.131.091	✓	2/20

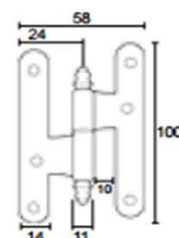

**pernio aluminio latonado sin remate 100x57x2,8**



mano	latonado	SK	
derecha	521.131.010	✓	20
izquierda	521.131.011	✓	20

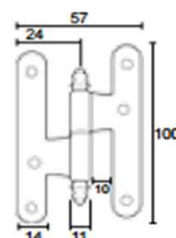

**pernio hierro con remate 100x58x2,0**

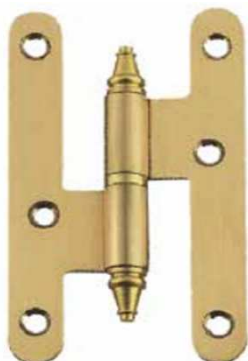

mano	negro	laton satinado	cuero	SK	
derecha	521.131.070	521.131.040	521.131.060	✓	2/20
izquierda	521.131.071	521.131.041	521.131.061	✓	2/20

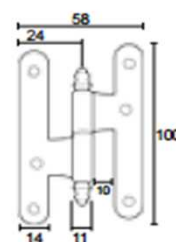

**pernio aluminio con remate 100x57x2,8**



mano	latonado	níquel satinado	SK	
derecha	521.131.109	521.131.107	✓	2/20
izquierda	521.131.116	521.131.114	✓	2/20

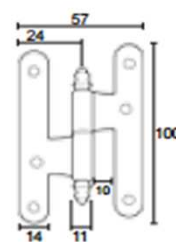

herrajes , pernios y bisagras decorativas



a



### 13.01 pernio 310 acero inox sin remate 100x59



mano	A	B	C	inox mate	SK	
derecha	100	59	14	521.811.302	✓	1/20
izquierda	100	59	14	521.811.313	✓	1/20

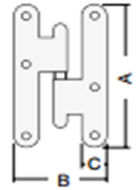

### pernio acero con remate cuero ingles 100x57



mano	A	B	C	cuero ingles	SK	
derecha	100	57	14	521.811.806	✓	1/20
izquierda	100	57	14	521.811.795	✓	1/20

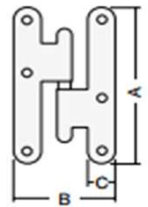

### pernio 410 laton remate redondo con rodamiento a bola

A	B	C	mano	laton mate	chromo	chromo mate	inox mate	SK	
100	55	13	derecha	521.811.440	521.811.462	521.811.448	521.811.506	✓	1/20
100	55	13	izquierda	521.811.451	521.811.473	521.811.495	521.811.510	✓	1/20
120	60	14,5	derecha	521.811.265	p 521.811.243	521.811.221		✓	1/10
120	60	14,5	izquierda	521.811.276	p 521.811.254	521.811.232		✓	1/10

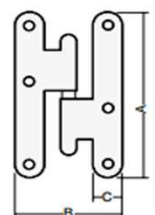

herrajes , pernios y bisagras decorativas



b

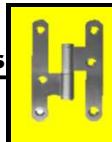

13.01

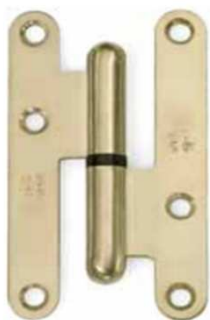
**pernio 403 acero remate redondo**

mano	A	B	C	latonado	SK	
derecha	95	52	14	521.811.891	✓	1/20
izquierda	95	52	14	521.811.902	✓	1/20

**pernio 420 SPR laton con remate redondo con rodamiento a bola**

mano	A	B	C	laton mate	SK	
derecha	100	55	13	521.811.521	✓	1/20
izquierda	100	55	13	521.811.532	✓	1/20
derecha	120	60	14,5	521.811.280	p	1/10
izquierda	120	60	14,5	521.811.291	p	1/10

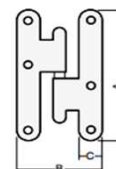
**pernio laton con remate 100x57x2,4**

mano	cuero	laton satinado	laton envejec.	SK	
derecha	521.131.101	521.131.103	521.131.108	✓	2/20
izquierda	521.131.118	521.131.110	521.131.115	✓	2/20

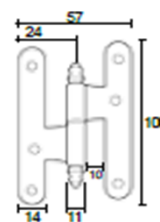
**pernio laton sin remate 100x57x2,4**

mano	laton satinado	nikel satinado	SK	
derecha	521.131.102	521.131.100	✓	2/20
izquierda	521.131.119	521.131.117	✓	2/20





### 13.01 pernio 310-5 laton con remate redondo con rodamiento a bola



Rodamiento a bola

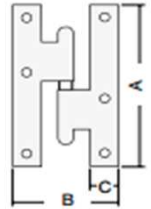

mano	A	B	C	laton mate	SK	
derecha	100	55	13	521.811.125	✓	1/20
izquierda	100	55	13	521.811.136	✓	1/20

### pernio 310-5 FUERTE laton con remate redondo con rodamiento a bola



Rodamiento a bola

Cromo

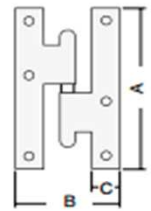

mano	A	B	C	laton mate	cromado	SK	
derecha	100	60	14,5	521.811.044	521.811.022	✓	1/20
izquierda	100	60	14,5	521.811.055	521.811.033	✓	1/20
derecha	120	65	16	521.811.081	521.811.066	✓	1/10
izquierda	120	65	16	521.811.092	521.811.070	✓	1/10
derecha	140	70	17	521.811.103			1/10
izquierda	140	70	17	521.811.114			1/10

### pernio 403 hierro con remate redondo



mano	A	B	C	latonado	SK	
derecha	95	52	14	521.811.605	✓	1/20
izquierda	95	52	14	521.811.616	✓	1/20
derecha	110	55	14	521.811.620	✓	1/20
izquierda	110	55	14	521.811.631	✓	1/20
derecha	140	55	16	521.811.642	✓	1/10
izquierda	140	55	16	521.811.653	✓	1/10

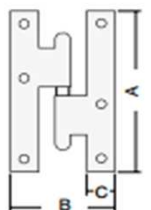

herrajes , pernios y bisagras decorativas



d



13.01

**bisagra acero de seguridad sin remate 150x80 canto cuadrado**

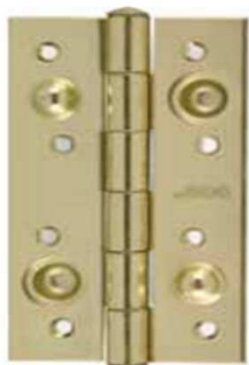

canto	latonado	efecto inox	SK	
cuadrado	521.131.981	521.131.414	✓	1

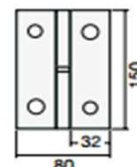

**bisagra acero de seguridad con remate 150x80**

canto	níquel sat.	cuero	latonado	cuero ingles	plata envej.	negro	SK	
redondo	521.131.842	521.131.811	521.131.804		521.131.859	521.131.835	✓	1
cuadrado	521.131.841	521.131.810	521.811.992	521.811.810	521.131.858	521.131.834	✓	1

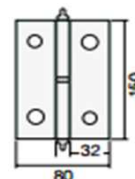
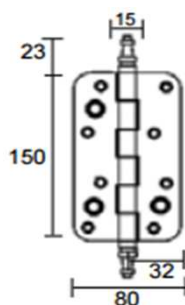

**bisagra acero de seguridad con remate 150x85**



canto	negro	anticuario	plata vieja	SK	
recto	521.811.185	521.811.196	521.811.200	✓	1



**bisagra acero de seguridad sin remate 150x80 canto redondo**



canto	efecto inox	SK	
redondo	521.131.543	✓	

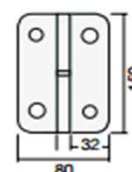

herrajes , pernios y bisagras decorativas





**13.01** bisagra acero inox AISI 306 de seguridad sin remate 150x80

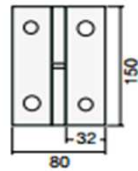
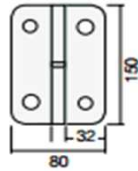

canto	acero inox	SK	
redondo	521.131.866	✓	1
cuadrado	521.131.865	✓	1

**pernio acero inox AISI 306 90x65 pala cerrada ancha**

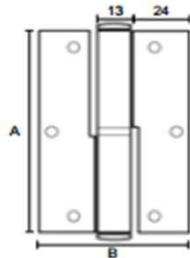
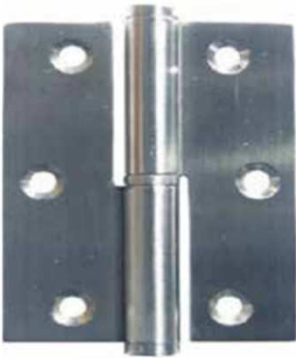

A	B	mano	acero inox	SK	
90	65	derecha	521.131.022	✓	1
90	65	izquierda	521.131.823	✓	1

**pernio acero inox 90x65 pala cerrada ancha**



embalaje	mano	acero inox	SK	
unitario	derecha	521.811.435	✓	1
unitario	izquierda	521.811.424	✓	1
industrial	derecha	521.981.413		100
industrial	izquierda	521.981.414		100

**pernio acero inox 90x65 pala abierta ancha**



A	B	C	D	mano	acero inox	SK	
90	65	27	16	derecha	521.811.700	✓	1
90	65	27	16	izquierda	521.811.696	✓	1
100	86	36	25	derecha	522.981.413	✓	1
100	86	36	25	izquierda	521.981.402	✓	1

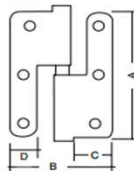

herrajes , pernos y bisagras decorativas



f

p= bajo pedido

✓= stock





13.02

**pernio hierro con remate 100x58x2,0**



	mano	negro	laton satinado	cuero	SK	
derecha		521.131.070	521.131.040	521.131.060	✓	2/20
izquierda		521.131.071	521.131.041	521.131.061	✓	2/20

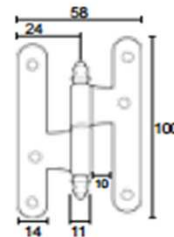

**pernio hierro forjado latonado sin remate 95x56**



	mano	negro	anticuario	plata vieja	SK	
derecha		521.811.244	521.811.266	521.811.281	✓	1/20
izquierda		521.811.255	521.811.270	521.811.292	✓	1/20

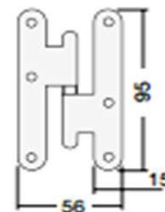

**pernio laton con remate 100x57x2,4**

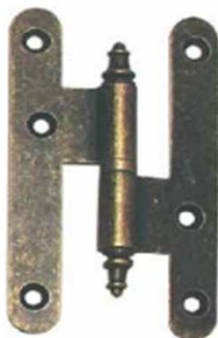

	mano	cuero	laton satinado	laton envejec.	SK	
derecha		521.131.101	521.131.103	521.131.108	✓	2/20
izquierda		521.131.118	521.131.110	521.131.115	✓	2/20

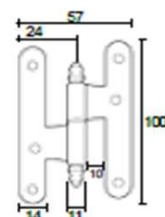

herrajes , pernios y bisagras decorativas



a



### 13.02 bisagra acero de seguridad con remate 150x80

canto	níquel sat.	cuero	latonado	cuero ingles	plata envej.	negro	SK	
redondo	521.131.842	521.131.811	521.131.804		521.131.859	521.131.835	✓	1
cuadrado	521.131.841	521.131.810	521.811.992	521.811.810	521.131.858	521.131.834	✓	1

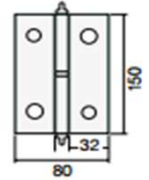
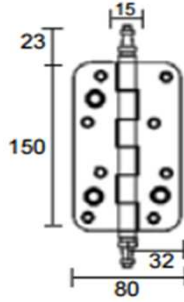

### bisagra acero de seguridad con remate 150x85

canto	negro	anticuario	plata vieja	SK	
recto	521.811.185	521.811.196	521.811.200	✓	1/20

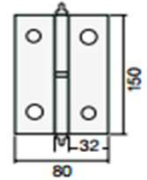

herrajes , pernios y bisagras decorativas



b





13.02

**pala decorativa R50 hierro forja**



negro	anticuario	plata vieja	SK	
✓ 521.811.743	521.811.754	521.811.765		1

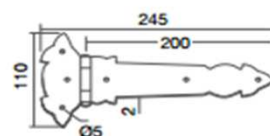

**pala decorativa GOLFO hierro forja**



negro	anticuario	plata vieja	SK	
✓ 521.811.211	522.811.222	521.811.233		1

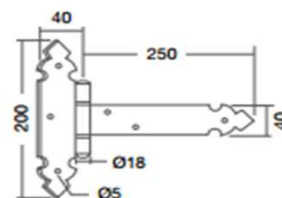

**pala decorativa CUADRA hierro forja**

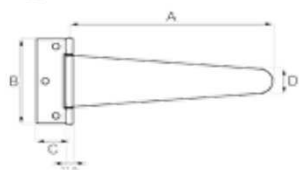

A	B	C	D	negro	SK	
109	75	38	11,5	522.131.108	✓	10
138	88	38	11,5	522.131.115	✓	10
155	88	38	11,5	522.131.116	✓	10
188	88	38	11,5	522.131.117	✓	10
207	111	45	12,5	522.131.118	✓	10
262	111	45	12,5	522.131.119	✓	10
312	111	45	12,5	521.131.120	✓	10

**pala decorativa T hierro forja**



A	B	C	D	negro	SK	
75	75	25	20	521.131.016	✓	2
100	95	28	25	521.131.017	✓	2

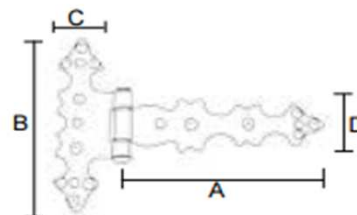

herrajes , pernios y bisagras decorativas



C



**13.02** bisagra decorativa **FUERTE** hierro forja



	negro	antiquario	plata vieja	SK	
	✓ 521.811.894	522.811.222	522.811.233		1

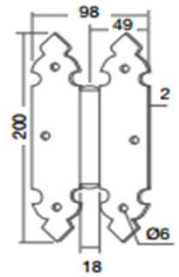

bisagra decorativa 7 hierro forja



	A	B	C	negro	SK	
	45	75	25	521.131.014	✓	2
	60	95	30	521.131.015	✓	2

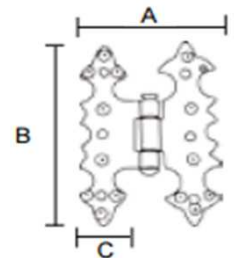

bisagra decorativa **MARIPOSA 6** hierro forja



	negro	SK	
	521.131.013	✓	2

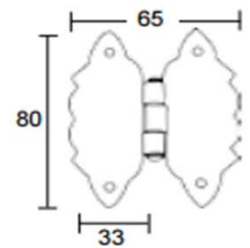

bisagra decorativa 11 hierro forja



	negro	antiquario	plata vieja	SK	
	✓ 521.811.010	521.811.393	521.811.404		1

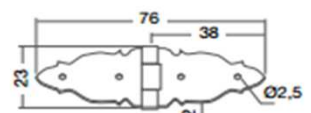

herrajes , pernios y bisagras decorativas



d



13.02

**bisagra decorativa MARIPOSA 14 hierro forja**



	negro	anticuario	plata vieja	SK	
	✓ 521.811.500	521.811.511	521.811.522	 SK	1

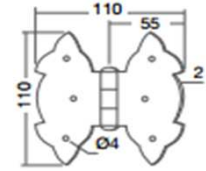

**bisagra decorativa MARIPOSA 15 hierro forja**



	negro	anticuario	plata vieja	SK	
	✓ 521.811.861	521.811.872	521.811.883	 SK	1

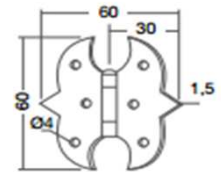

herrajes , pernios y bisagras decorativas



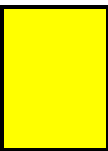

13.02

herrajes , pernios y bisagras decorativas



f

p= bajo pedido

✓= stock



13.03

**juego bisagra pivotante ARNO para puertas desde 35 mm y hasta 35 kg**

SIN REGULACIONES



material	apertura	efecto inox	SK	
acero	180°	513.811.324	✓	1

Cada código se compone de la bisagra alta y baja.



Posibilidad de combinarlo con cierre intermedio cód. 513.811.394

**juego bisagra pivotante QUADRATA para puertas desde 35 mm y hasta 50 kg**

SIN REGULACIONES



material	apertura	efecto inox	SK	
acero	180°	513.811.335	✓	1

Cada código se compone de la bisagra alta y baja.



Posibilidad de combinarlo con cierre intermedio cód. 513.811.394

**juego bisagra pivotante CYRANO 2R para puertas desde 35 a 45 mm y hasta 70 kg**

material	descripcion	apertura	cincado	chromo brillo	chromo mate	SK	
acero+zamak+ABS	bisagra con regulacion	110°	513.811.420			✓	1
acero+zamak+ABS	tapa cubre regulacion(1 por bisagra)			513.811.361	513.811.372	✓	1



Regulaciones: Lateral +/- 3 mm y profundidad +/- 1,5 mm



Cada código se compone de la bisagra alta y baja.

Tapa



Posibilidad de combinarlo con cierre intermedio cód. 513.811.394

**juego bisagra pivotante ARISTO 2R para puertas desde 35 mm y hasta 70 kg**

material	descripcion	apert.	chromo brillo	chromo mate	SK	
acero+zamak+ABS	bisagra con regulacion	180°		513.811.350	✓	1
acero+zamak+ABS	tapa cubre regulacion(1 por bisagra)		513.811.361	513.811.372	✓	1



Regulaciones: Lateral +/- 3 mm y profundidad +/- 1,5 mm



Cada código se compone de la bisagra alta y baja.

Tapa



Posibilidad de combinarlo con cierre intermedio cód. 513.811.394

✓ = stock

p = bajo pedido





### 13.03 juego bisagra pivotante DINO 3R para puertas desde 35 A 45 mm y hasta 80 kg



material	descripcion	apertura	efecto inox	SK	
zamak+acero	bisagra con regulacion	180º	513.811.383	✓ ✓	1

Regulaciones: Altura 0/+ 3 mm, lateral +/- 1,5 mm y profundidad +/- 1 mm

Cada código se compone de la bisagra alta y baja.



Posibilidad de combinarlo con cierre intermedio cód. 513.811.394

### cierre intermedio regulable para ptas con bisagra pivotante



descripcion	niquelado	SK	
cierre	513.811.394	✓	1

En instalaciones para puertas pivotantes, es recomendable la instalación del cierre intermedio, principalmente para puertas altas. Su instalación es en el lado bisagra, para evitar que la puerta pudiese arquear.



### juego bisagra pivotante recta



medida	latonado	SK	
80x10	513.131.001	✓	24

1 juego = 4 machos y 4 hembras

### juego bisagra pivotante angulo



medida	latonado	SK	
60x10	513.131.002	✓	24

1 juego = 2 machos izquierda, 2 machos derecha, 2 hembras izquierda y 2 hembras derecha

herrajes , pernios y bisagras decorativas



b





13.03

**juego bisagra pivotante MAR**

ACERO INOX

	acero inox	SK	
	513.123.688		1

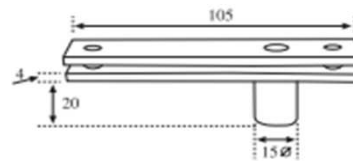
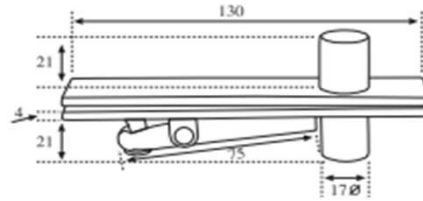

Regulacion en altura.

**juego bisagra hidraulica pivotante IN puerta madera**

ACERO INOX

	PESO	acero inox	SK	
	100 KG	513.360.204		1

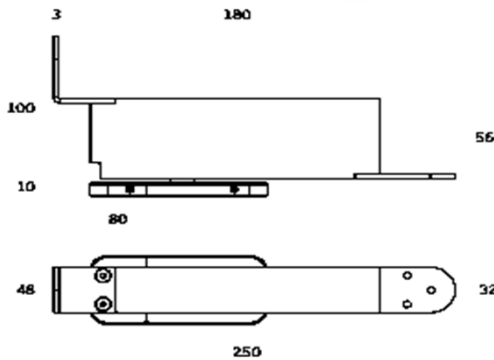
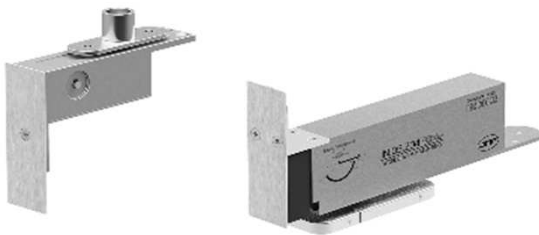

Juego completo de pivote hidraulico para puertas de madera.

- Dos velocidades de cierre regulables por valvulas.
- Anchura max. de la puerta 1000mm.
- Peso max. 100Kg.
- Espesor del madera ≥ 40mm.
- Sistema para ajustar la posicion EN 3D.
- Aplicable a la superficie del suelo.

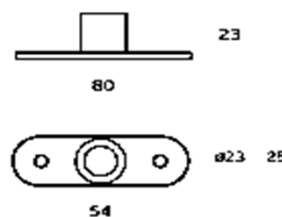
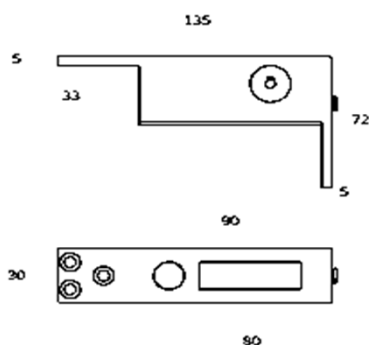
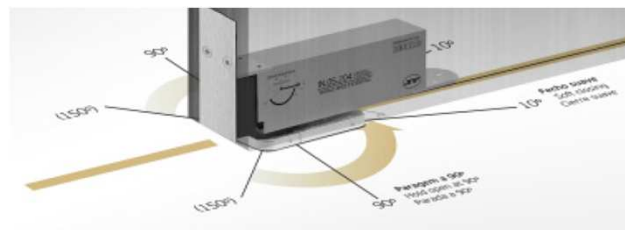

herrajes , pernios y bisagras decorativas



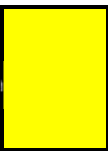

13.03

 herrajes , pernios y bisagras decorativas

d

p= bajo pedido

✓= stock



13.04

**bisagra oculta acero inox apertura 180º**

ACERO INOX



A	B	C	acero inox	SK	
95	19	27	514.811.392	✓	1

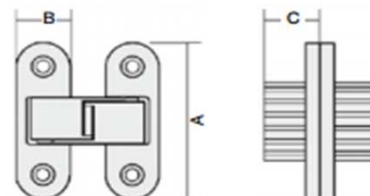

**bisagra oculta acero inox-nylon apertura 180º**

ACERO INOX-NYLON



A	B	C	inox/blanco	SK	
90	25	20	514.811.171	✓	1

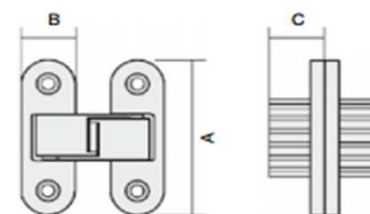

**bisagra oculta 4 acero inox apertura 180º**

ACERO INOX



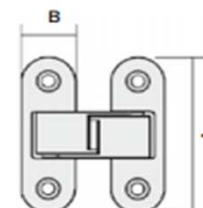

A	B	acero inox	SK	
60	12,7	514.131.354	✓	2
70	15,8	514.131.355	✓	2
95	19,5	514.131.356	✓	2

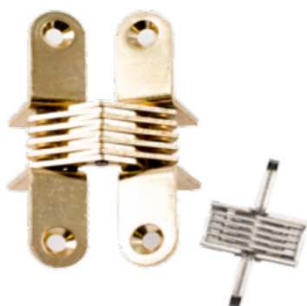

**bisagra oculta mesa apertura 180º**

ACERO



medidas	latonado	níquel	bronce	SK	
65x13	514.131.350	514.131.351	513.811.352	✓	1

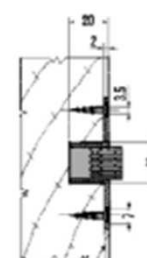
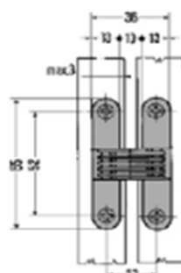

herrajes , pernios y bisabras decorativas



a

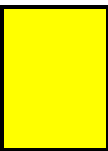

13.04

 herrajes , pernios y bisagras decorativas

 b

p= bajo pedido

✓= stock



13.05

**bisagra oculta KUBICA K-6400 5 pivotes 3 regulaciones 35/45 kg apertura 180°**

ZAMAK

Kg x 3 bis.	espesor min.pta	efecto inox	chromo mate	dorado	SK	
45	30mm	✓ 522.811.345	522.811.334	522.811.356		1



Presenta un sistema de autocentrado del tornillo de fijación de la bisagra al cerco y a la puerta. No tiene mano. Autoportante: Regulación por excéntrica sin acuñar la puerta. Incluye tapas. Viene con cazoletas tapadas por fundición. Reducido encastre en marco de 18 mm.

Características técnicas:

Triple regulación con apertura 180°. Anchos de puerta de 600 a 900 mm. Altura de puerta 2100 mm (2/3 bisagras) para más altura usar 4 bisagras. Espesor puerta mínimo de 30 mm. Peso: 2 bisagras 35Kg, 3 bisagras 45Kg.

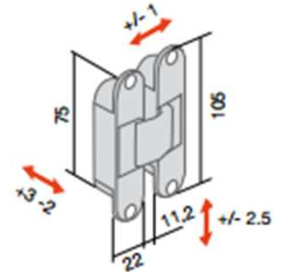
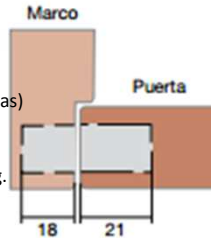

La profundidad de la cazoleta del lado del marco es de 18 mm, del lado de la puerta de 21 mm.

**bisagra oculta KUBICA K-6200 5 pivotes 3 regulaciones 45/60 kg apertura 180°**

ZAMAK

Kg x 3 bis.	espesor min.pta	efecto inox	chromo mate	dorado	SK	
60	35mm	✓ 522.811.203	522.811.214	522.811.225		1



No tiene mano. Autoportante: Regulación por excéntrica sin acuñar la puerta. Incluye tapas. Viene con cazoletas tapadas por fundición

Características técnicas:

Triple regulación con apertura 180°. Anchos de puerta: 600 a 900 mm. Altura de puerta 2100 mm (2/3 bisagras) para más altura usar 4 bisagras. Espesor puerta mínimo de 35 mm. Peso: 2 bisagras 45Kg, 3 bisagras 60Kg.

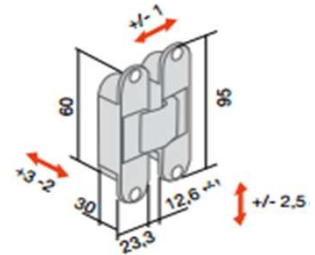

Certificada y testada al fuego según normativa europea EN 1634.2. I nforme de Prueba N° 945-946.0UN0360/10



**bisagra oculta KUBICA K-6700 5 pivotes 3 regulaciones 50/70 kg apertura 180°**

ZAMAK

Kg x 3 bis.	espesor min.pta	efecto inox	chromo mate	dorado	SK	
70	40mm	✓ 522.811.135	522.811.146	522.811.150		1



No tiene mano. Autoportante: Regulación por excéntrica sin acuñar la puerta. Incluye tapas. Viene con cazoletas tapadas por fundición

Características técnicas:

Triple regulación con apertura 180°. Anchos de puerta máximo 900 mm. Altura de puerta 2100 mm (2/3 bisagras) para altura superior a 2700 mm usar 4 bisagras. Espesor puerta mínimo de 40 mm. Peso: 2 bisagras 50Kg, 3 bisagras 70Kg.

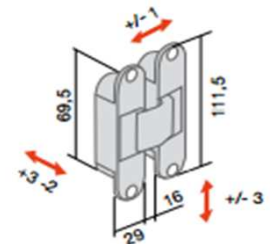
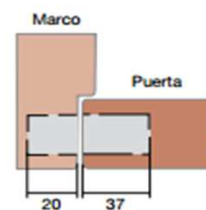

La profundidad de la cazoleta del lado del marco es de 20 mm, del lado de la puerta de 37 mm.

herrajes , pernios y bisagras decorativas



a



### 13.05 bisagra oculta KUBICA K-5080 5 pivotes 3 regulaciones 80/100 kg apertura 180º

ZAMAK

Kg x 3 bis.	espesor min.pta	chromo mate	SK	
100	40mm	522.811.065	✓	1



#### Medidas diseñadas para la sustitución de otras bisagras del mercado.

No tiene mano. Autoportante: Regulación por excéntrica sin acuñar la puerta. Incluye tapas a fijar con tornillos. Viene con cazoletas tapadas por fundición

#### Características técnicas:

Triple regulación con apertura 180º.  
 Anchos de puerta: 600 a 900 mm.  
 Altura de puerta 2.100 mm (2/3 bisagras), para más altura consultar.  
 Espesor puerta mínimo de 40 mm.  
 Peso: 2 bisagras 80Kg, 3 bisagras 100K

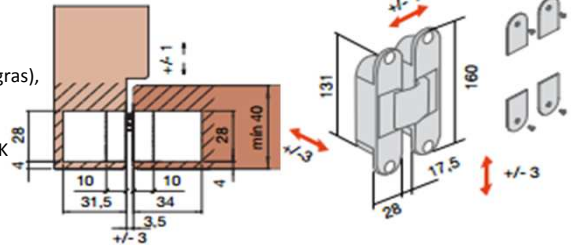

#### NOTA:

Opcionalmente cuando tenemos marco metálico se puede solicitar el cajetín para su fijación. También opcionalmente existen placas de fijación para soportar pesos superiores a 80 Kg (ver PDF en web)

### bisagra oculta KUBICA 27 K-2700 autocentrante 5 pivotes 3 reg. 60 kg apertura 180º

ZAMAK

Kg x 3 bis.	esp. min.pta	efecto inox	chromo mate	SK	
60	35mm	✓	522.811.155	522.811.144	1

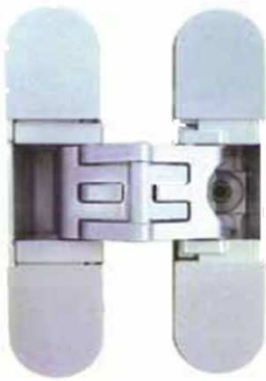

Al ser autocentrante, ella queda regulada en el centro del grueso de la hoja.

No tiene mano.

Autoportante: Regulación por excéntrica sin acuñar la puerta.

Incluye tapas. Viene con cazoletas tapadas por fundición

#### Características técnicas:

Triple regulación con apertura 180º.  
 Anchos de puerta: 600 a 900 mm.  
 Altura de puerta 2.100 mm (3 bisagras), para más altura consultar.  
 Uso obligado de 3 bisagras soportando 60kg  
 Espesor puerta mínimo de 35 mm y máximo 45 mm. Instalándose a 17,5 mm desde el canto exterior de la puerta.  
 La profundidad de la cazoleta del lado del marco es de 30mm, del lado de la puerta de 40mm

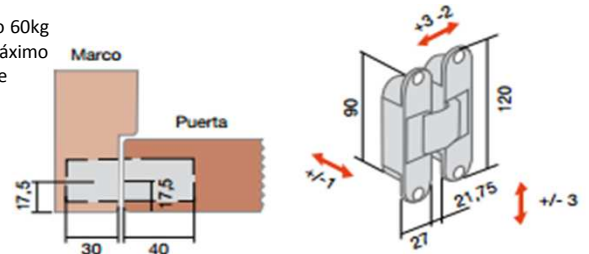

### bisagra oculta KUBICA 7 K-7000 7 pivotes 3 regulaciones 40/50 kg apertura 180º

ZAMAK

Kg x 3 bis.	esp. min.pta	efecto inox	chromo mate	dorado	negro	SK	
50	35mm	✓	522.811.625	522.811.636	522.811.640	522.811.651	1



No tiene mano.

Autoportante: Regulación por excéntrica sin acuñar la puerta.

Incluye tapas. Viene con cazoletas tapadas por fundición.

Con una profundidad reducida de 22,5mm.

#### Características técnicas:

Triple regulación con apertura 180º. Anchos de puerta: 600 a 900 mm.  
 Altura de puerta 2100 mm (2/3 bisagras) para más altura consultar.  
 Espesor puerta mínimo de 35 mm. Peso: 2 bisagras 40Kg, 3 bisagras 50Kg.

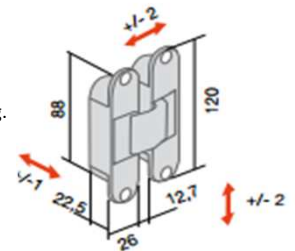

#### NOTA:

Opcionalmente cuando tenemos marco metálico se puede solicitar el cajetín para su fijación.

herrajes, pernios y bisagras decorativas



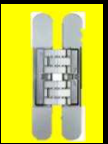

13.05

**bisagra oculta KUBICA 7 K-7080 7 pivotes 3 regulaciones 80/100 kg apertura 180°**

ZAMAK



Kg x 3 bis.	esp. min.pta	efecto inox	chromo mate	SK	
100	40mm	✓	522.811.181	522.811.192	1

**No tiene mano.**
**Autoportante: Regulación por excéntrica sin acuñar la puerta.**
**Incluye tapas. Viene con cazoletas tapadas por fundición**
**Características técnicas:**

Triple regulación con apertura 180°.  
 Anchos de puerta: 600 a 900 mm.  
 Altura de puerta 2.100 mm (2/3 bisagras),  
 para más altura consultar.  
 Espesor puerta mínimo de 40 mm.  
 Peso: 2 bisagras 80Kg, 3 bisagras 100Kg

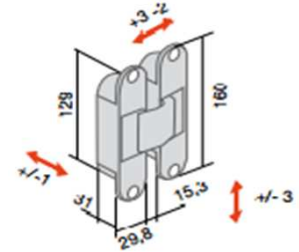

Certificada según normativa europea  
 EN1935:2002 y CUAP 04.05/12 v.2006 y  
 testada al fuego según normativa europea EU 1634.1



NOTA: Opcionalmente cuando tenemos marco metálico se puede solicitar el cajetín para su fijación.  
 También opcionalmente existen placas de fijación para soportar pesos superiores a 80 Kg

**bisagra oculta KUBICA 7 K-7120 7 pivotes 3 regulaciones 120/140 kg apertura 180°**

ZAMAK



Kg x 3 bis.	esp. min.pta	efecto inox	chromo mate	SK	
140	40mm	✓	522.811.096	522.811.085	1

**No tiene mano. Autoportante:**
**Regulación por excéntrica sin acuñar la puerta.**
**Incluye tapas. Viene con cazoletas tapadas por fundición**
**Características técnicas:**

Triple regulación con apertura 180°.  
 Anchos de puerta: 600 a 900 mm.  
 Altura de puerta 2100 mm (2/3 bisagras)  
 para más altura usar 4 bisagras.  
 Espesor puerta mínimo de 35 mm.  
 Peso: 2 bisagras 120Kg, 3 bisagras 140Kg.

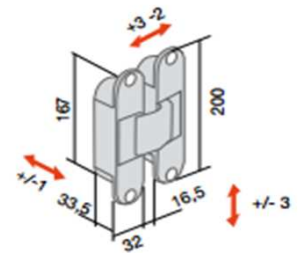

Certificada según normativa europea  
 EN1935:2002 y CUAP 04.05/12 v.2006 y  
 testada al fuego según normativa europea EU 1634.1



NOTA: Opcionalmente cuando tenemos marco metálico se puede solicitar el cajetín para su fijación.  
 También opcionalmente existen placas de fijación para soportar pesos superiores a 80 Kg

**bisagra oculta KUBICA 7 K-7200 7 pivotes 3 regulaciones 200 kg apertura 180°**

ZAMAK



Kg x 2 bis.	esp. min.pta	efecto inox	chromo mate	SK	
200	40mm	✓	522.811.111	522.811.100	1

**No tiene mano. Autoportante:**
**Regulación por excéntrica sin acuñar la puerta.**
**Incluye tapas. Viene con cazoletas tapadas por fundición**
**Características técnicas:**

Triple regulación con apertura 180°. Anchos  
 de puerta máximo 900 mm. Altura de puerta  
 2100 mm (2/3 bisagras) para altura superior  
 a 2700 mm usar 4 bisagras.  
 Espesor puerta mínimo de 40 mm.  
 Peso: 2 bisagras 200Kg,

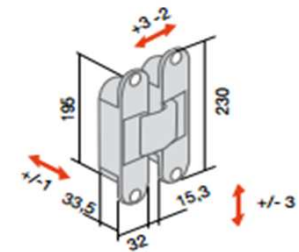

NOTA: Opcionalmente cuando tenemos marco metálico se puede solicitar el cajetín para su fijación.  
 También opcionalmente existen placas de fijación para soportar pesos superiores a 80 Kg

herrajes , pernios y bisagras decorativas





### 13.05 bisagra oculta KUBIKUADRA K-3000 5 pivotes 3 regulaciones 60 kg apertura 160º

ZAMAK

**PUERTAS SOLAPADAS**

Kg x 3 bis.	esp. min.pta	efecto inox	chromo mate	SK	
60	45mm	✓ 522.811.380	522.811.376		1



No tiene mano.

**Autoportante:** Regulación por excéntrica sin acuñar la puerta. Incluye tapas. Viene con cazoletas tapadas por fundición

**Características técnicas:**

Triple regulación con apertura 160º. Permite realizar puertas solapadas (10x10m) enrasadas con tapeta, con una separación d 13,5 mm y un espesor de 45 mm (35 mm m: solapa de 10 mm). Anchos de puerta: 600 a 900 mm. Es necesario instalar un tope para que el movimiento de la apertura de la puerta no dañe la bisagra (estando ésta limitada a 160º mecánicamente).  
 Altura de puerta 2100 mm (3 bisagras), para más altura consultar. Espesor puerta mínimo de 45 mm.  
 Peso: 3 bisagras 60Kg

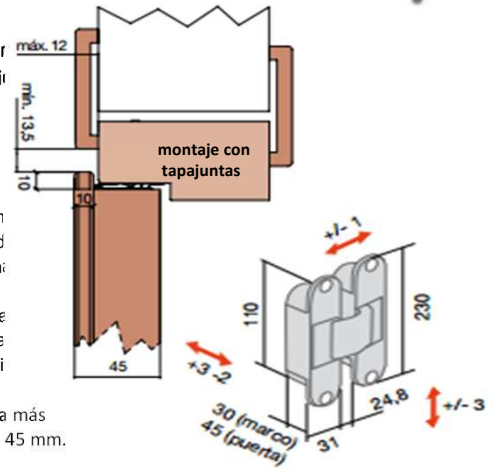

### bisagra oculta KUBICA K-6300 autocentrante 5 pivotes 3 reg. 60 kg apertura 180º

ZAMAK

**PUERTA ENRASADA A TAPETA**

Kg x 3 bis.	esp. min.pta	efecto inox	chromo mate	SK	
60	45mm	✓ 522.811.076	522.811.080		1



No tiene mano.

**Autoportante:** Regulación por excéntrica sin acuñar la puerta. Incluye tapas. Viene con cazoletas tapadas por fundición

**Características técnicas:**

Triple regulación con apertura 180º. Anchos de puerta: 600 a 900 mm. Altura de puerta 2100 mm (2/3 bisagras) para más altura usar 4 bisagras. Espesor puerta mínimo de 45 mm.  
 Peso: 3 bisagras 60Kg.

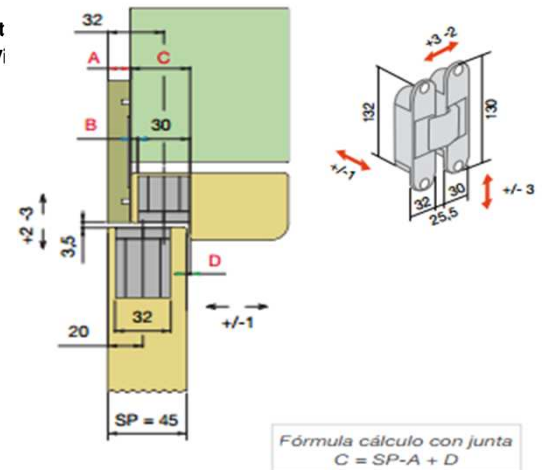

Certificada y testada al fuego según normativa europea EN 1634.2. Informe de Prueba Nº 945-946.0UN0360/10



### bisagra oculta KUBICA K-2400 5 pivotes 3 regulaciones 40/60 kg apertura 180º

ZAMAK

**PUERTAS FINAS O GALCEADAS**

Kg x 3 bis.	esp. min.pta	efecto inox	chromo mate	SK	
52	25mm	✓ 522.811.365	522.811.354		1



No tiene mano.

**Autoportante:** Regulación por excéntrica sin acuñar la puerta. Incluye tapas. Viene con cazoletas tapadas por fundición.

Con una profundidad reducida de 22,5r

**Características técnicas:**  
 Triple regulación con apertura 180º. Anchos de puerta máx. 900 mm. Altura máx. de puerta 2.100 mm (2/3 bisagra). Espesor puerta mínimo 25 mm. Peso: de 40kg con 2 bisagras, de 52kg con 3 bisagras. La profundidad de la cazoleta del lado del marco es de 24 mm (21 mm de ancho del lado de la puerta de 27 mm (18 de ancho

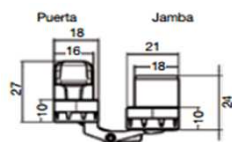
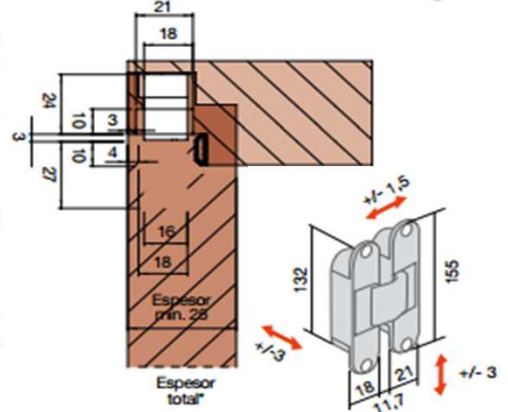

\*Espesor total ha de ser el necesario (o deseado) siendo igual o superior a 25 mm

herrajes, pernios y bisagras decorativas



d

p= bajo pedido

✓ stock

**13.05**
**bisagra oculta KUBI 7 KUBIKA TWIST 7 pivotes 3 regulaciones 60 kg apertura 180º**

ZAMAK

**CON MUELLE**

Kg x 3 bis.	esp. min.pta	efecto inox	chromo mate	SK	
60	40mm	✓ 522.811.133	522.811.122		1



Bisagra provista de sistema de cierre automático, lo que le permite retener a 30 y 90º y con 3 velocidades de cierre. No tiene mano.

Autoportante: Regulación por excéntrica sin acuñar la puerta. Incluye tapas. Viene con cazoletas tapadas por fundición

**Características técnicas:**

Triple regulación con apertura 180º.  
 Anchos de puerta: 600 a 900 mm.  
 Altura de puerta 2.100 mm (2/3 bisagras), para más altura consultar. Espesor puerta mínimo 40 mm. Peso: 60kg con 3 bisagras. La profundidad de la cazoleta del lado del marco es de 31 mm, del lado de la puerta de 64 mm

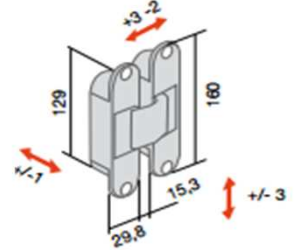
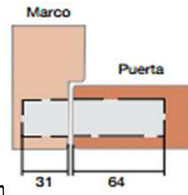

NOTA: Opcionalmente cuando tenemos marco metálico se puede solicitar el cajetín para su fijación

**bisagra oculta ALFA 29 ECO 3 regulaciones 40 kg apertura 180º**

ZAMAK

Kg x 3 bis.	esp. min.pta	plata mate	SK	
40	30mm	522.914.029		12



Con nuestra bisagra ALFA 29, podrá regular su puerta de un máximo de 40 kg. en sus 3 ejes. Dada sus múltiples regulaciones, será muy sencilla su colocación y graduación.

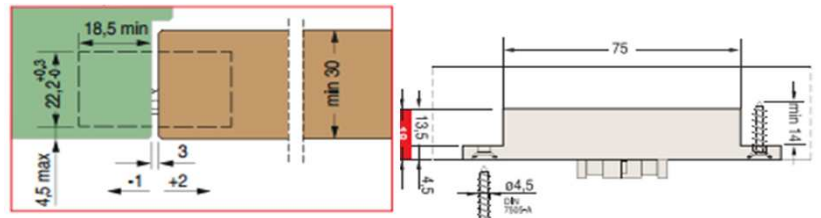
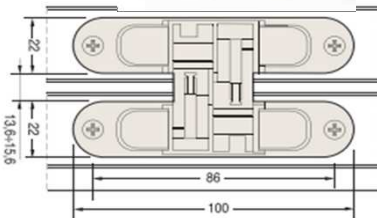

**bisagra oculta ALFA 30 ECO 3 regulaciones 60 kg apertura 180º**

ZAMAK

Kg x 3 bis.	esp. min.pta	acabado	SK	
60	32mm	plata	522.914.030	9
60	32mm	negro	522.914.131	9
60	32mm	bronce	522.914.132	9
60	32mm	acero inox	522.914.133	9
60	32mm	blanco	522.914.134	9

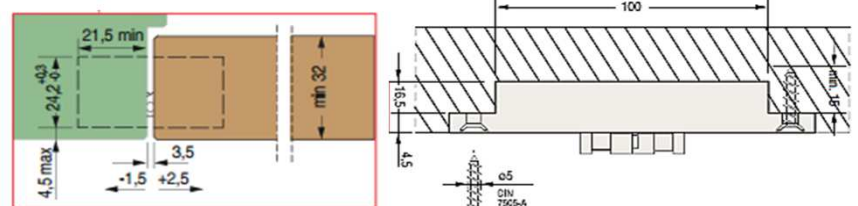
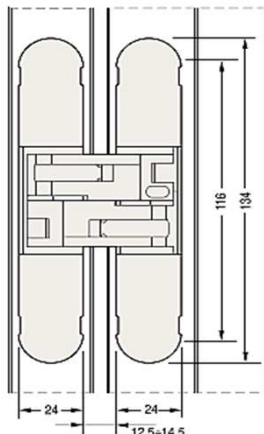

ALFA 30 es una bisagra para puertas de un máximo de 60 kg. de peso. Cuenta con sistema 3D para poder regularla en sus 3 ejes y con una amplia variedad de acabados.





### 13.05 bisagra oculta ALFA 31 ECO 3 regulaciones 120 kg apertura 180º

ZAMAK

Kg x 3 bis.	esp. min.pta	plata mate	SK	
40	30mm	522.914.032		12



ALFA 31 es una bisagra especialmente fabricada para puertas de gran tamaño y peso, con una carga máxima de 120 kg. y con regulación 3D.

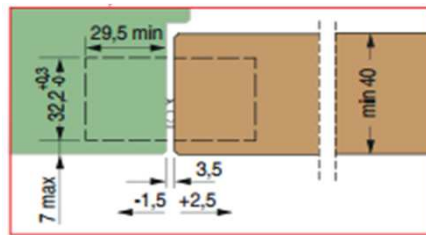
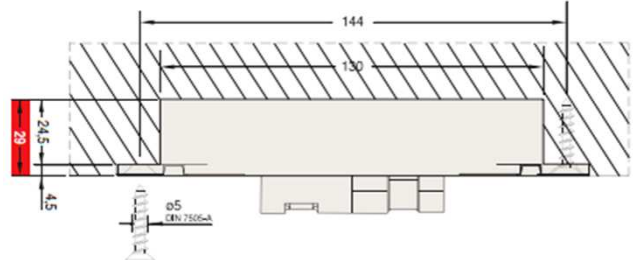
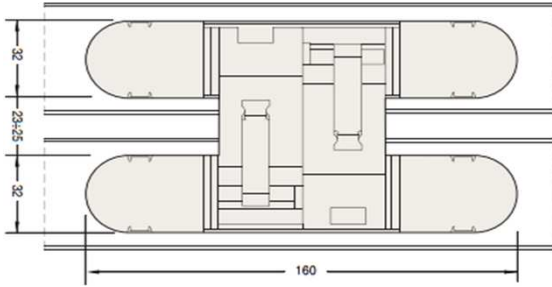

### bisagra oculta ALFA 32 ECO 3 regulaciones 70 kg apertura 180º

ZAMAK

Kg x 3 bis.	esp. min.pta			SK	
70	35mm	aluminio	522.914.032		6
70	35mm	níquel	522.914.132		6
70	35mm	oro	522.914.033		6



ALFA 31 es una bisagra especialmente fabricada para puertas de gran tamaño y peso, con una carga máxima de 120 kg. y con regulación 3D.

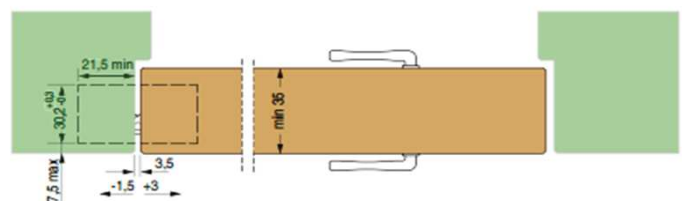
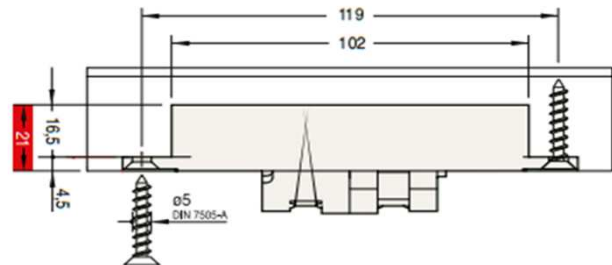
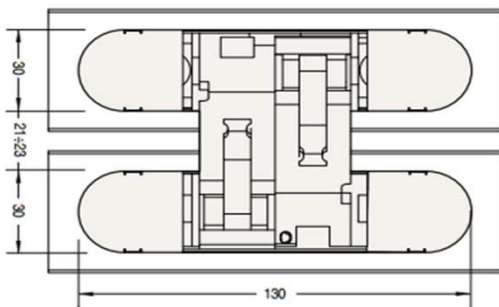





13.06

**pernio anuba sin remate 44x13**



material	latonado	SK	
zamak	521.811.174	✓	1

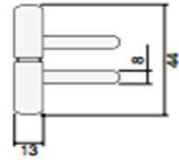

acabados negro y niquel satinado consultar.

**pernio anuba con remate 87x13**



material	bronce	latonado	SK	
zamak	521.811.530	521.811.163	✓	1

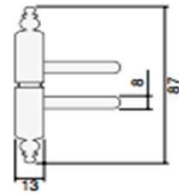

**pernio anuba regulable con embellecedores**

bricomatado	bricomatado	nylon negro	alum.plata sat.	aluminio oro	SK	
anuba	521.811.560				✓	1
embellecedor		521.811.593	521.811.571	521.811.582	✓	1

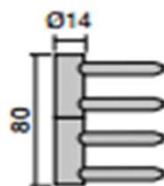

herrajes , pernios y bisagras decorativas



**13.06** pernio anuba con remate 90x13



negro	SK	
521.123.845		20

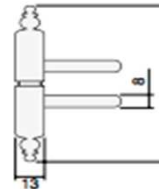

**pernio anuba con remate 90x13 macho/hembra**

descripcion	latonado	níquel satinado	bronce	cuero	negro	SK	
macho	513.123.725	513.123.728	513.123.724	513.123.831	513.123.726		100
hembra	513.123.212	513.123.565	513.123.785	513.123.830	513.123.870		100

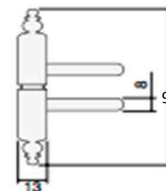

**pernio anuba sin remate 44x13 macho/hembra**

descripcion	latonado	níquel sat.	negro	SK	
macho	513.123.722	513.123.808	513.123.720		160
hembra	513.123.207	513.123.807	513.123.586		160

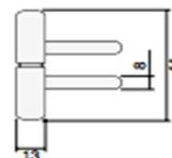

herrajes , pernios y bisagras decorativas



**b**

p= bajo pedido

✓= stock





**bisagra de librillo**  
ACERO/ACERO INOX



ancho	latonado	niquelado	inox brillo	SK	
32mm	524.811.431	524.811.453	524.811.475	✓	3,5mt
32mm	524.811.494	524.811.405	524.811.516	✓	50mt
40mm	524.811.442	524.811.465	524.811.486	✓	3,5mt
40mm	524.811.505	524.811.416	524.811.520	✓	50mt

**bisagra biombo**  
LATON



A	B	laton pulido	SK	
60	25	524.811.075	✓	1

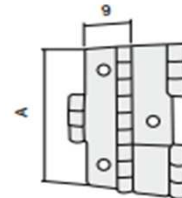

**bisagra 553 doble plancha en alas**  
ACERO



A	B	cincado	SK	
50	50	524.811.490	✓	1
60	60	524.811.501	✓	1
70	70	524.811.512	✓	1
80	80	524.811.523	✓	1
100	100	524.811.534	✓	1
120	120	525.811.545	✓	1
140	140	525.811.556	✓	1

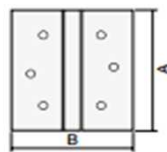

**bisagra 553 doble plancha en ala desmontable**  
ACERO



A	B	cincado	SK	
80	70	524.811.310	✓	1

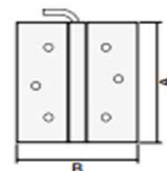

herrajes , pernios y bisagras decorativas





**13.07** bisagra allisa plana final chato  
ACERO/LATON/ACERO INOX



A	B	acero latona.	inox brillo	SK	
35	30	524.811.531	524.811.010	✓	1
40	35	524.811.542	524.811.021	✓	1
50	40	524.811.553	524.811.032	✓	1
60	40	524.811.564	524.811.043	✓	1
60	50	524.811.575	524.811.054	✓	1
70	50	524.811.586	524.811.065	✓	1

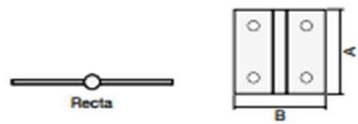

**bisagra anika plana final con remate**  
ACERO/LATON



A	B	acero latona.	laton	SK	
50	40		524.811.913	✓	1
60	50		524.811.936	✓	1
70	50	524.811.704	524.811.940	✓	1

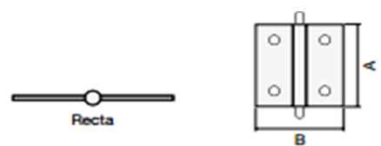

**bisagra wolf acodada final chato**  
ACERO/LATON



A	B	acero latona.	laton	SK	
35	30	524.811.590		✓	1
40	40	524.811.601	524.811.844	✓	1

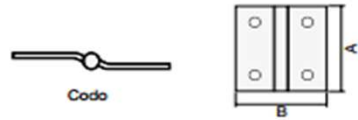

**bisagra tino acodada final con remate**  
ACERO/LATON



A	B	acero latona.	laton	SK	
40	35	524.811.726		✓	1
50	40		524.811.973	✓	1
60	50	524.811.752		✓	1

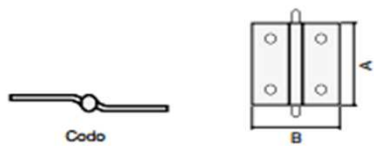

herrajes , pernios y bisagras decorativas



p= bajo pedido

✓= stock



13.07

**bisagra estuche**

ACERO



A	B	latonado	SK	
13	15	524.131.305	✓	6
13	20	524.131.306	✓	6
13	25	524.131.307	✓	4

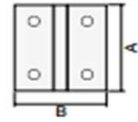

**pala decorativa T hierro forja**



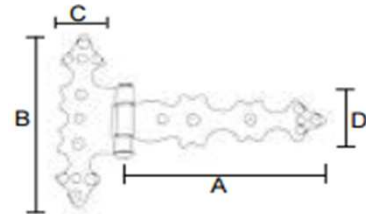

A	B	C	D	negro	SK	
75	75	25	20	521.131.016	✓	2
100	95	28	25	521.131.017	✓	2



**bisagra decorativa MARIPOSA 14 hierro forja**



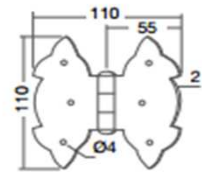

negro	antiquario	plata vieja	SK	
✓ 521.811.500	521.811.511	521.811.522		1



**bisagra decorativa MARIPOSA 15 hierro forja**



negro	antiquario	plata vieja	SK	
✓ 521.811.861	521.811.872	521.811.883		1

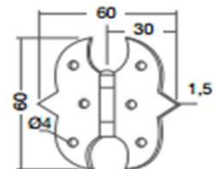

herrajes , pernios y bisagras decorativas



**13.07** bisagra decorativa **FUERTE** hierro forja

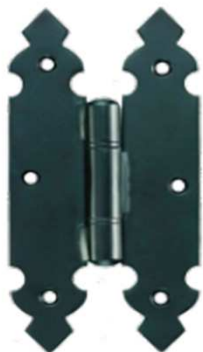

	negro	antiquario	plata vieja	SK	
	✓ 521.811.894	522.811.222	522.811.233		1

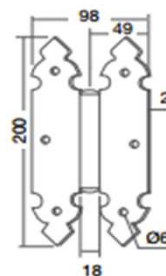

bisagra decorativa **7** hierro forja



	A	B	C	negro	SK	
	45	75	25	521.131.014	✓	2
	60	95	30	521.131.015	✓	2

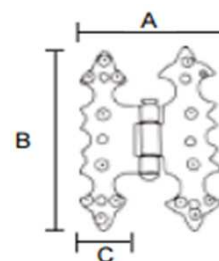

bisagra decorativa **MARIPOSA 6** hierro forja



	negro	SK	
	521.131.013	✓	2

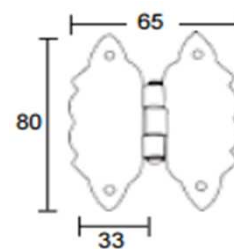

bisagra decorativa **11** hierro forja



	negro	antiquario	plata vieja	SK	
	✓ 521.811.010	521.811.393	521.811.404		1

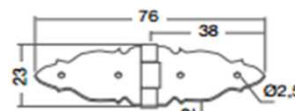

herrajes , pernios y bisagras decorativas



d

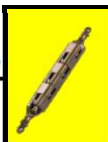

13.08

**bisagra bublac sin remate**

ZAMAK

A	B	laton envej.	chromo	latonado	SK	
40	10	524.131.944	524.131.943	524.131.942	✓	2
53	10	525.131.947	524.131.946	524.131.945	✓	2
55	9		524.811.143	524.811.154	✓	1



**bisagra bublac con remate**

ZAMAK

A	B	laton envej.	chromo	latonado	SK	
87	10	524.131.939	524.131.940	524.131.941	✓	2
87	10	524.131.947	525.131.946	525.131.945	✓	2
94	9	524.811.176			✓	1

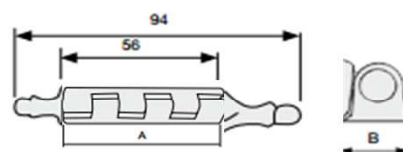

**bisagra sato para puertas abatibles**

ZAMAK

	niquel	SK	
	524.811.770	✓	1

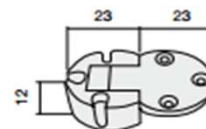

**bisagra pantalón tipo mesa**

LATON LAMINADO

	laton mate	chromado	SK	
	524.811.036	524.811.343	✓	1

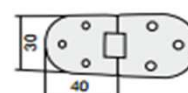

Tope a 180°.

herrajes , pernios y bisagras decorativas



a

✓ = stock

p = bajo pedido



**13.08** bisagra pata abatible con clip de fijacion

ACERO



cincado	SK	
524.811.182	✓	1

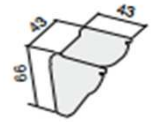

**bisagra embutida cilindrica oculta**

LATON



A	B	C	laton mate	SK	
10	11	8	524.811.766	✓	1
12	13,5	8	524.811.316	✓	1
14	15,5	8	524.811.320	✓	1
16	16,5	8	524.811.331	✓	1
18	18	8	524.131.372	✓	2
24	25	8	524.131.373	✓	2

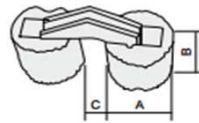

**bisagra BS2 oculta mesa 65x13**

ACERO

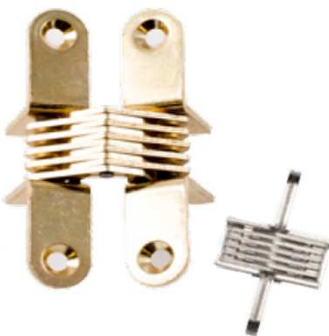

latonado	niquel	bronce	SK	
524.131.682	524.131.683	524.131.684	✓	2

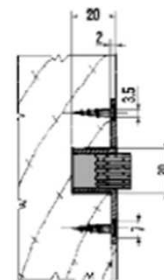
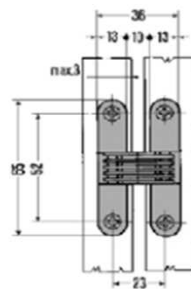

herrajes , pernios y bisagras decorativas



b





**bisagra KUBIKINA K-6100 3 regulaciones hasta 19 kg apertura 180º ZAMAK**

descripcion	chromo mate	negro	roja	blanca	marron	SK	
bisagra+tapas	524.811.545	524.811.556				✓	1
tapas*			524.811.560	524.811.571	524.811.582	p	120

\* Pedido mínimo de 120 uds. (30 juegos de tapas)

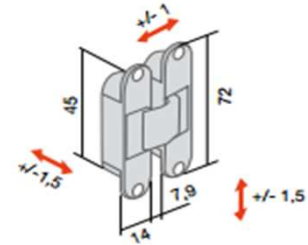
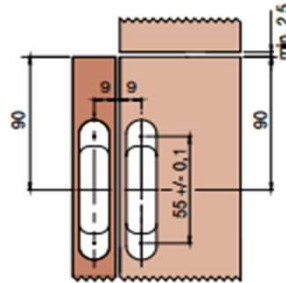

Bisagra oculta para mueble regulable en 3 ejes de forma independiente. Ideal para hojas abatibles, elimina el estorbo de las bisagras tradicionales. Espesor de puerta mínimo de 18 mm.

**Medidas de alto y peso máximo:**

- 2 bisagras: Hasta 1000 mm. y 10,5 Kgs.
- 3 bisagras: Hasta 1500 mm. y 14 Kgs.
- 4 bisagras: Hasta 2000 mm. y 19 Kgs.

Posibilidad de instalarse mediante plantilla de mecanizado.

**bisagra mostrador 80x30**

LATON



	laton pulido	laton mate	niquel	SK	
	524.298.513	524.298.045	524.298.100	✓	1

**bisagra mostrador 80x30x2,5**

ACERO



	latonado	cuero	SK	
	524.131.386	524.131.387	✓	2





**13.08** bisagra mostrador 80x32x1,5  
ACERO



latonado	cincado	SK	
524.131.366	524.131.367	✓	2

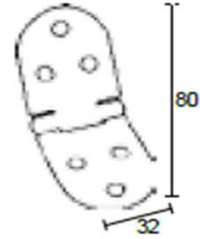

**bisagra oculta B5 4 sin regulaciones**  
ACERO INOX



A	B	inox	SK	
60	12,7	524.131.354	✓	2
70	15,8	524.131.355	✓	2
95	19,5	524.131.356	✓	2

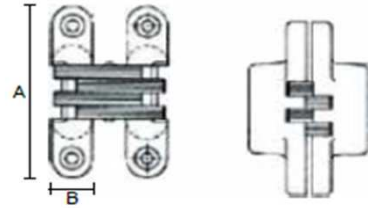

herrajes , pernios y bisagras decorativas

**bisagra kimana ascendente y descendente**  
ZAMAK



descripcion	NIQUELADO	SK	
bisagra	524.811.912	✓	1
separador H=1,5	524.811.923	✓	1
separador H=3,0	524.811.934	✓	1
separador H=4,0	524.811.945	✓	1

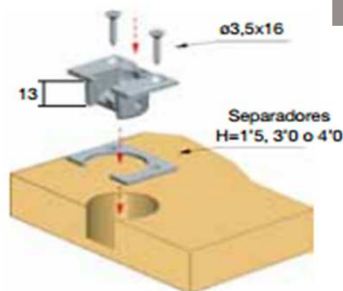
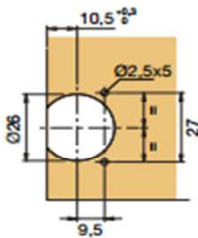

Separador H=1'5. 3'0 y 4'0

Profundidad de cazoleta de 13 mm.

p= bajo pedido

✓= stock





13.08

**juego bisagra pivotante recta**



medida	latonado	SK	
80x10	513.131.001	✓	24

1 juego = 4 machos y 4 hembras

**juego bisagra pivotante angulo**



medida	latonado	SK	
60x10	513.131.002	✓	24

1 juego = 2 machos izquierda, 2 machos derecha, 2 hembras izquierda y 2 hembras derecha

**bisagra sobreponer 104X44**

ACERO



cincado	SK	
524.131.504	✓	2



**bisagra pivotante mini**

ACERO

“Sin mano”. Cada puerta necesita 2 piezas.



chromo brillo	SK	
524.811.306	✓	2

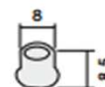
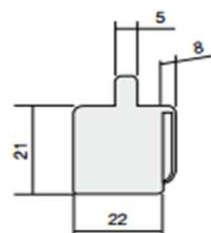



**13.08** bisagra embutida decorativa 32 mm



regul.	efecto inox	niquelado	cuero	SK	
no	525.557.125	525.557.105	525.557.115	✓	10
si	525.557.126	525.557.106	525.557.116	✓	10



con regulacion

Regulación vertical, lateral y frontal.

**bisagra embutida decorativa 32mm 3 regulaciones**

ZAMAK

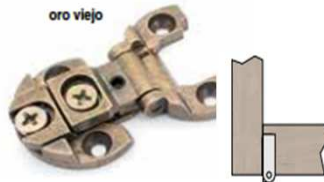

oro viejo	chromo ral 9006	niquel	SK	
525.298.056	525.298.057	525.298.058	✓	10/500



chromo RAL 9006

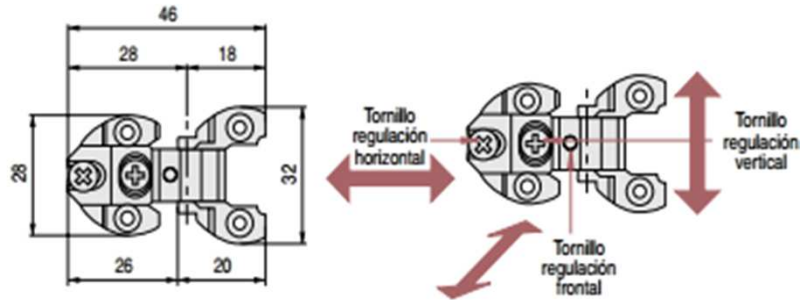

herrajes , pernios y bisagras decorativas

**bisagra DONCEL con remate 32mm 3 regulaciones**

ZAMAK



niquel



oro viejo

oro viejo	chromo ral 9006	niquel	SK	
525.298.061	525.298.062	525.298.063	✓	1/500

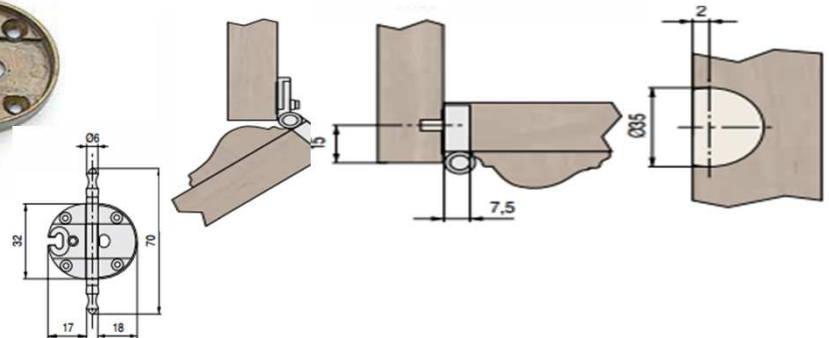

Regulación vertical, lateral y frontal.



13.08

**bisagra cazoleta FRAME 50 especial marco estrecho**

ACERO

descripcion	alt.	cierre	apertura	SK	
bisagra		muelle	105°	511.811.826	✓ 1/500
base	3			511.811.830	✓ 1/500

Base para bisagra

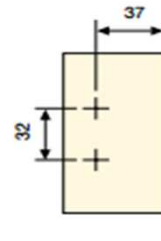
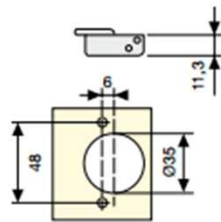
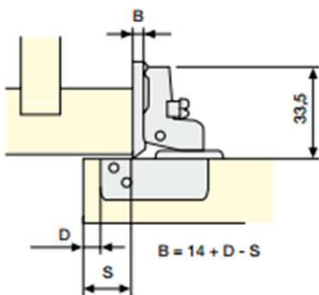

**bisagra doble cazoleta inglete d:35**



descripcion	cierre	apertura	SK	
bisagra	muelle	120°	511.298.128	✓ 1/25

- Inglete de 45° •
- Ajuste en altura de 3mm., ajuste en ancho y profundidad 1,5mm.
- Grosor de la puerta 16 a 22 mm.
- Grosor de pared lateral 16 a 20 mm, a partir de 20mm es preciso biselar el canto 3mm.

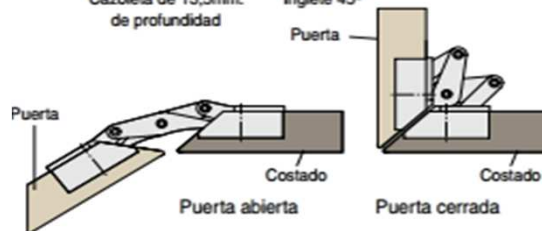
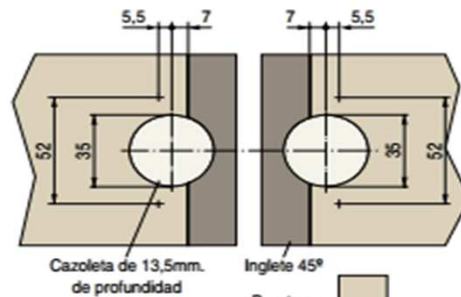
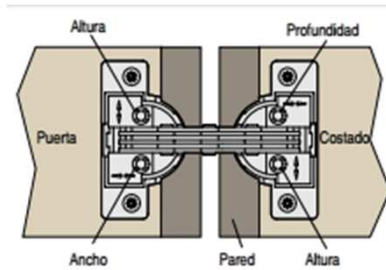

herrajes , pernios y bisagras decorativas







13.08 bisagra doble cazoleta rincon



descripcion	ciere			
bisagra	muelle	511.811.310	✓	1

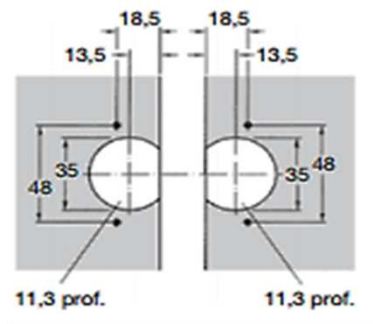

Puerta Cerrada

Puerta Abierta

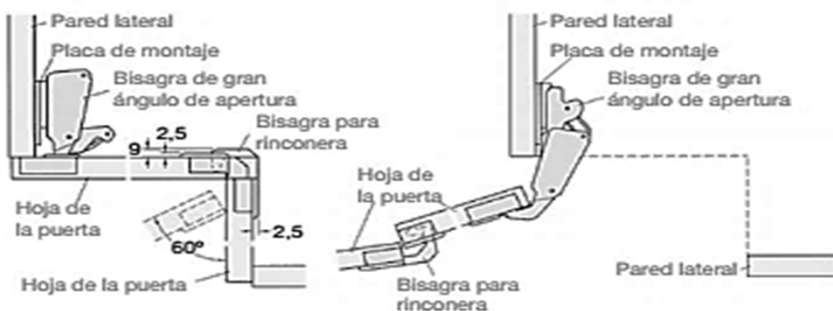

bisagra para cristal 6mm fijacion en costado ZAMAK



descripcion	negro mate	SK	
juego bisagras	524.811.106	✓	1
tirador	524.811.110	✓	1

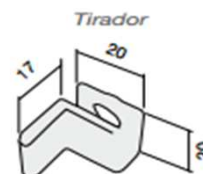
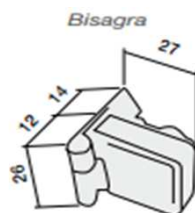

herrajes , pernios y bisagras decorativas



p= bajo pedido

✓ = stock



13.08

**bisagra cazoleta DECORATIVA d:35**

ZAMAK

descripc	acabado	cierre	remate		SK	
bisagra	cuero	golpete	si	513.557.113	✓	1/100
bisagra	gris	golpete	si	513.557.114	✓	1/100
bisagra	gris	golpete	no	513.557.115	✓	1/100



detalle sin remate

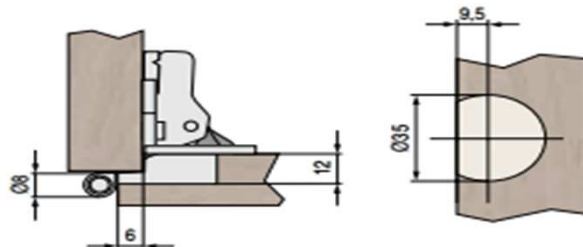

**bisagra DECORATIVA D:35 REGULABLE**

ZAMAK

descripc	acabado	cierre	remate		SK	
bisagra	bronce	golpete	si	513.298.423	✓	1/100

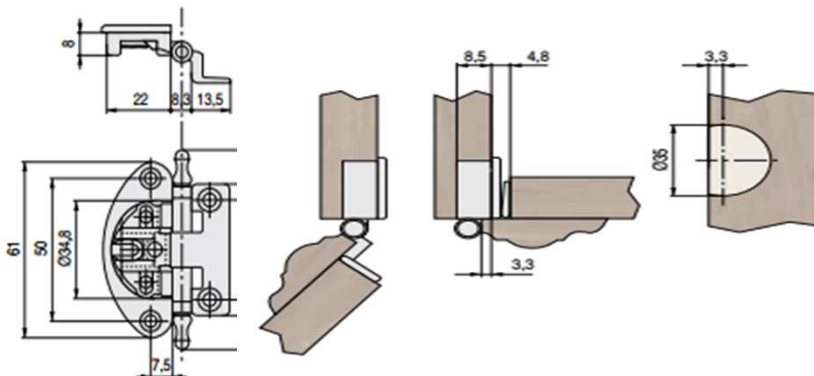

Regulación vertical, lateral y frontal.







### 13.08 bisagra DONCEL sin remate 32mm 3 regulaciones

ZAMAK

	oro viejo	chromo ral 9006	níquel		
	525.298.153	525.298.195	525.298.127	✓	1



oro viejo



níquel

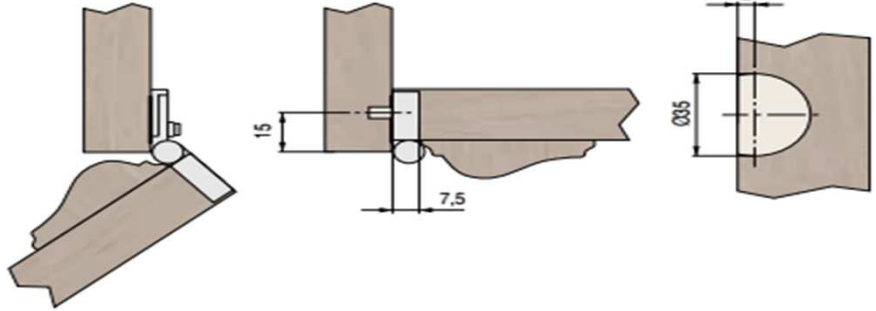
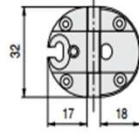

### bisagra cazoleta ALMAGRO d:35

ZAMAK

	acabado	remate		SK	
	oro viejo	si	525.298.516	✓	1/500
	oro viejo	si	525.298.518	✓	1/500
	níquel	no	525.298.519	✓	1/500

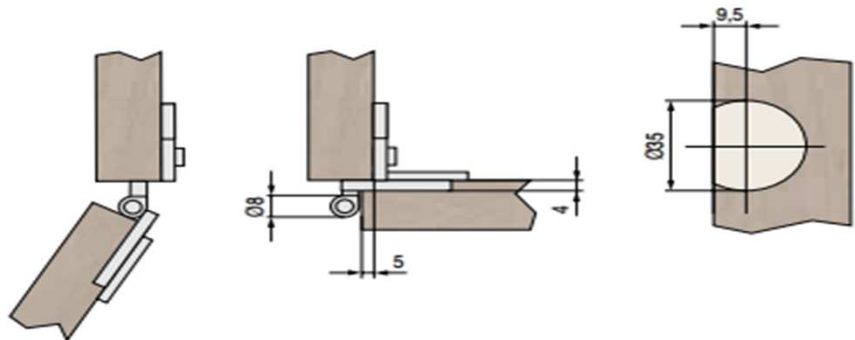
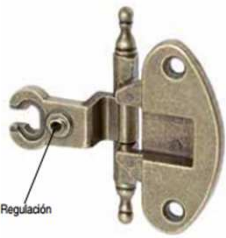

bisagras especiales

### bisagra cazoleta CIFUENTES d:26

ZAMAK

	acabado	remate		SK	
	oro viejo	si	525.298.525	✓	1/300
	plata vieja	si	525.298.526	✓	1/300

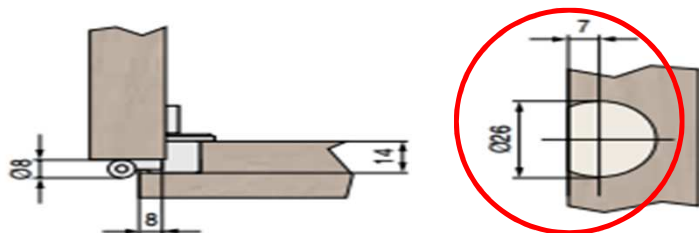
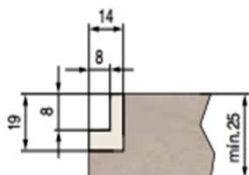



13.08

**bisagra cazoleta HITA d:26**

ZAMAK



acabado	remate		SK	
oro viejo	no	525.298.521	✓	1/350
níquel	no	525.298.520	✓	1/350

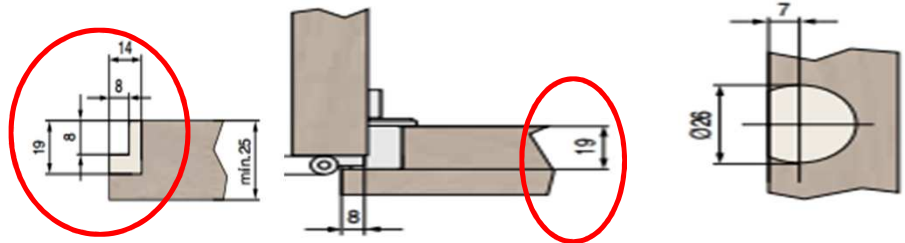

**bisagra cazoleta LAYNA d:26**

ZAMAK



acabado	remate		SK	
oro viejo	no	525.298.523	✓	1/350
níquel	no	525.298.527	✓	1/350

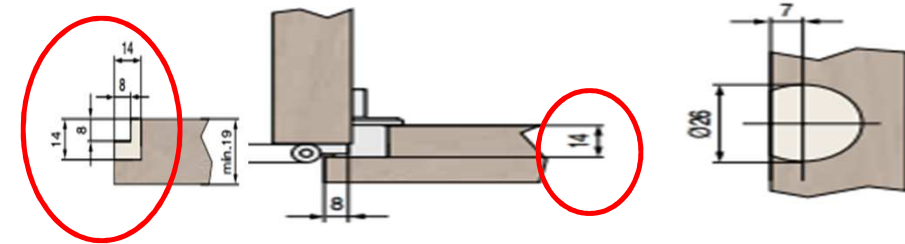

**bisagra cazoleta SINGER**

ZAMAK



acabado	apertura		SK	
níquel	90°	525.298.024	✓	1/20

- Regulaciones, vertical, profundidad y altura.
- Desmontable.
- Se pueden montar las distintas cazoletas por separado y luego unirlas para facilitar el montaje.
- Para taladros de Ø35mm. con pestaña embellecedora para tapar el borde de los agujeros.

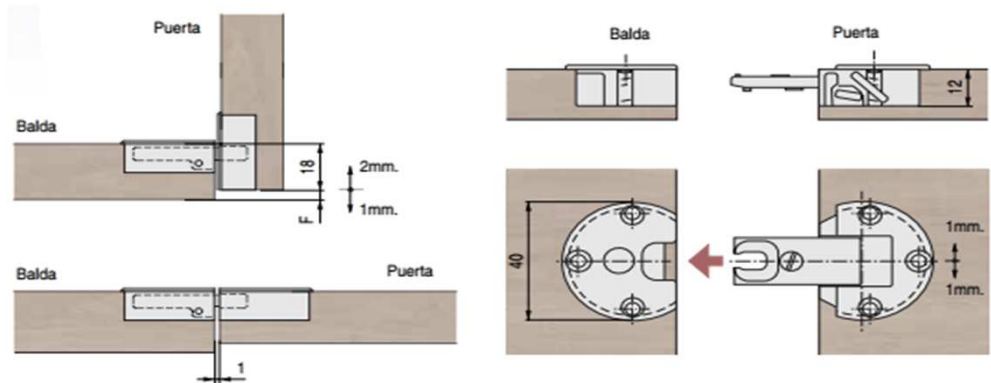
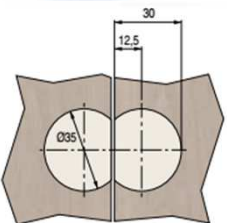

bisagras especiales



k



**13.08** bisagra RIBA doble cazoleta 180°

ZAMAK

**acabado**

níquel 525.298.224 1/100

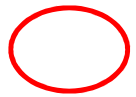
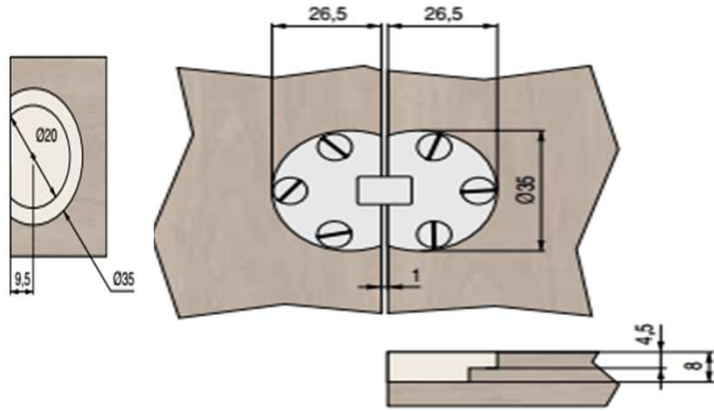

**bisagra CLARES** doble cazoleta 180°

ZAMAK

**acabado**

latonado 525.298.014 1/150  
níquel 525.298.015 1/150

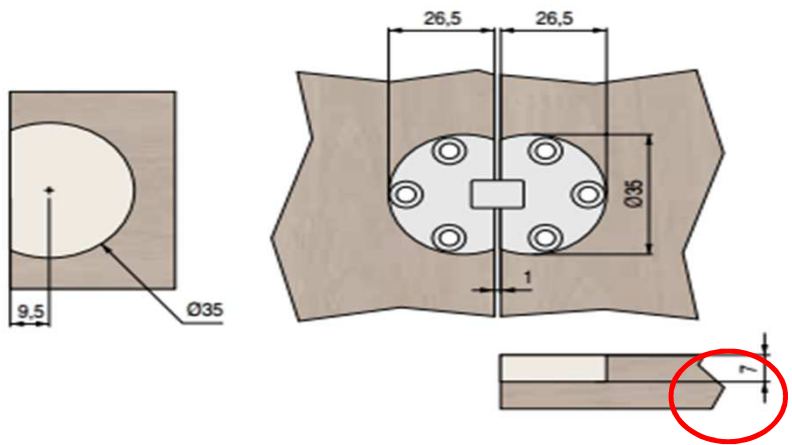

**bisagra SELAS** para tapa de mesas

PLASTICO/ZAMAK

**acabado**

marron 525.298.814 1/50

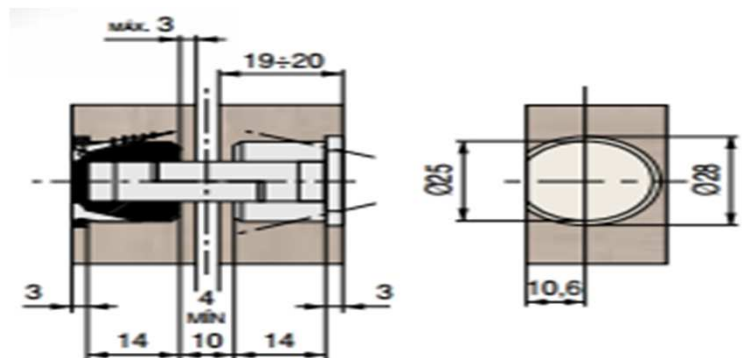

bisagras especiales

