



13.09

**pie nivelador GABRIEL**



M	A	B	C		SK	
m6	20	5,5	d:17	551.722.802		1000
m8	30	10	d:22	551.811.115		10/500
m10	30	10	d:22	551.811.513		10/500

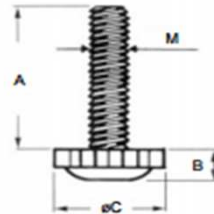

**pie nivelador D:40**



M	H	descripcion		SK	
m8	22	nivelador	551.722.302		100
m10	32	nivelador	551.722.402		100
		cobertura cromo mate	551.722.538		100
		cobertura cromo brillo	551.722.516		100

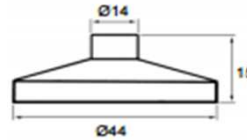
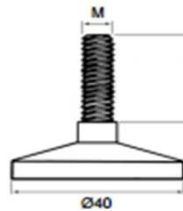

**pie nivelador BATH**



descripcion	SK	
nivelador	551.722.461	1000

se sirve desmontado.

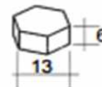
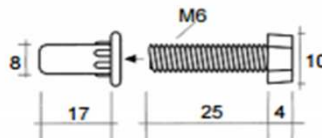

**pie nivelador NEI M10**



descripcion	SK	
nivelador	551.722.414	500

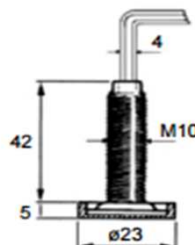

- Base inclinable.
- Utilizar llave allen de 4mm

= stock

= bajo pedido





13.09 pie nivelador NEI 2 M10

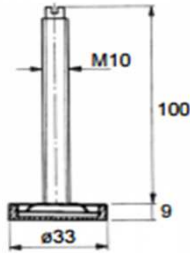

descripcion	SK	
nivelador	551.722.462	300

- Base inclinable.
- Utilizar destornillador plano.

soporte escuadra para pie nivelador NEI y NEI 2

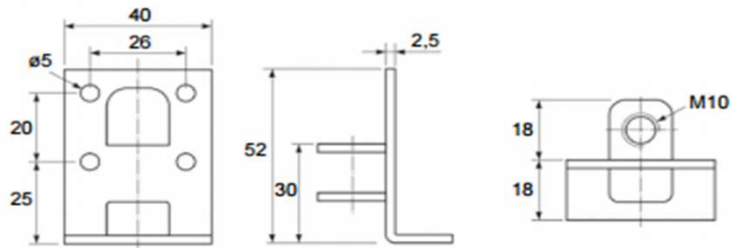

descripcion	SK	
soporte	551.722.462	328

soporte escuadra con pie nivelador NEI

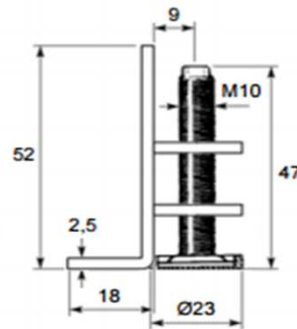

descripcion	SK	
soporte	551.722.514	300

pie nivelador JUSTI CLAVABLE

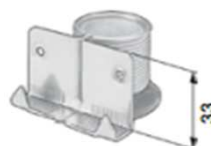

Regulación hasta 20  
Carga máxima de 150 Kg.  
por nivelador.

	SK	
	551.811.535	1/10





13.09

**pie nivelador FLORA sobrepuesto**  
MADERA/PLASTICO

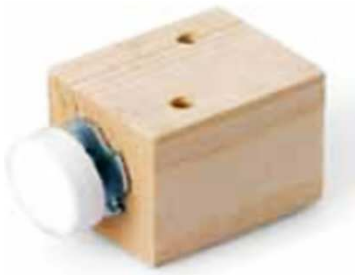

			SK	
	551.811.222	✓		1/100

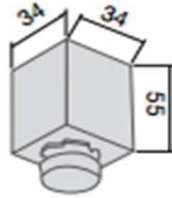

**pie nivelador INTEGRATOR**



	carga		SK	
	175 kg	551.811.171	✓	10/100

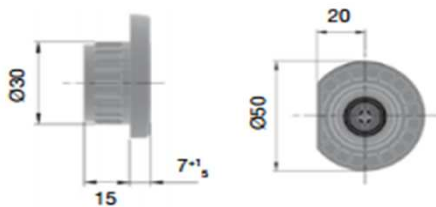
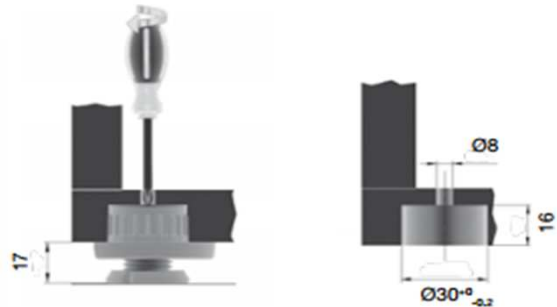

**pie nivelador GLIDE con regulacion de 21 mm**



H	descripcion		SK	
17	nivelador	551.811.473	✓	10/500
27	nivelador	551.811.484	✓	10/500
44	nivelador	551.811.495	✓	10/500

Regulable a través de nivelador interior.  
La pata se eleva quedando apoyada en el nivelador.  
Regulable hasta 21 mm por medio de allen de 4 mm

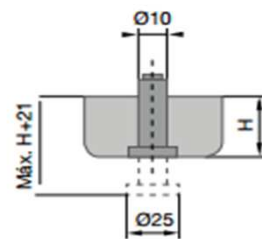
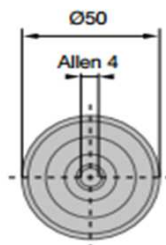

✓ = stock

p= bajo pedido

herrajes , patas y niveladores





13.09 pie nivelador LV 902



descripcion	SK	
nivelador	551.722.140	500

- Nivelador de superficie para base a suelo.
- Regulable de 0 a 35mm.
- 3 regulaciones posibles: superior e inferior con llave allen 4mm. e inferior con llave fija 8mm.
- Carga máxima 150Kg.

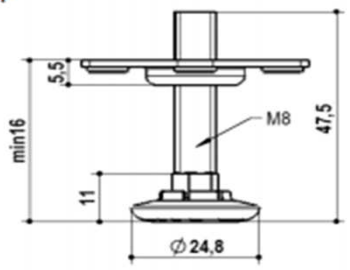
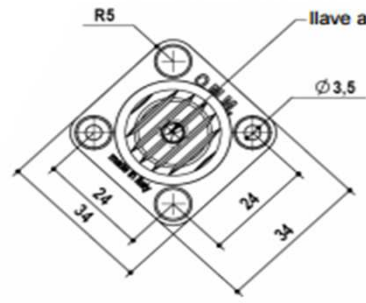

pie nivelador LV 302



descripcion	SK	
sopORTE	551.722.144	500

- Nivelador de empotrar para base a suelo.
- Regulable de 0 a 10mm.
- Carga máxima 150Kg.
- Utilizar llave allen 4mm.
- Tapón niquelado OPCIONAL(consultar).

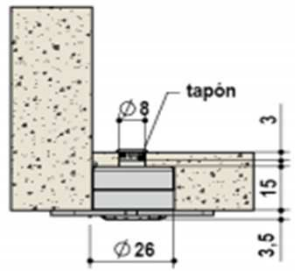
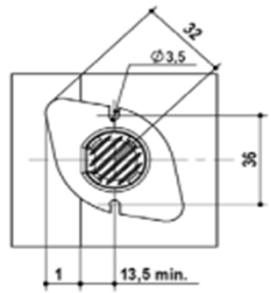



**pie nivelador LV 101**

SK

551.722.101



400



Figura 1



- Los niveladores de la serie LV101 se montan normalmente bajo costado.
- Apropiado para nivelar una amplia tipología de muebles (armarios, estanterías, módulos, etc.)
- Capacidad de carga: 150Kg.
- Regulable de 0 a 15mm.
- Compatible con distanciadores de 10, 23 y 38mm lo que permite configurar el nivelador según la altura solicitada.
- Los distanciadores tienen la función de:
  - 1 - Aumentar la capacidad de carga a la base.
  - 2 - Mantener fijo el nivelador cuando se desplaza el mueble.
  - 3 - Simplifica la regulación haciendo de guía a la llave allen.

**DISTANCIADOR para pie nivelador LV 101**

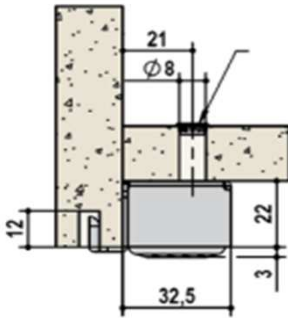
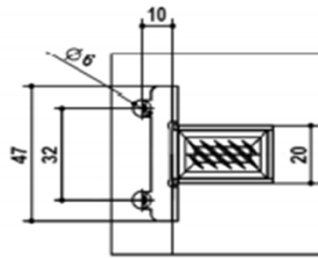
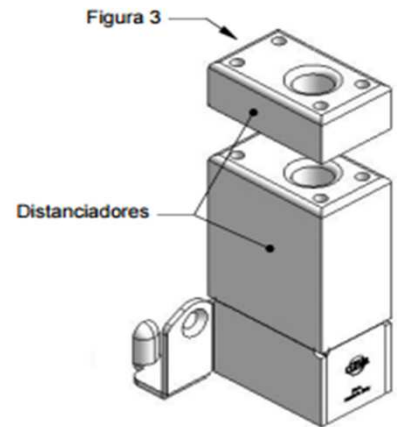
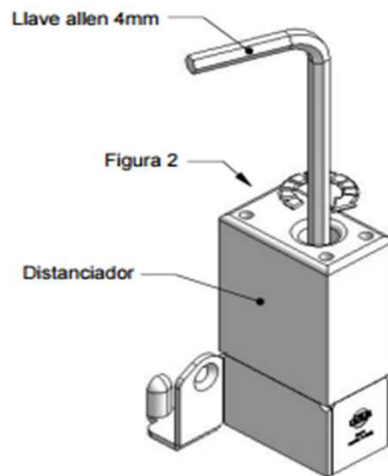
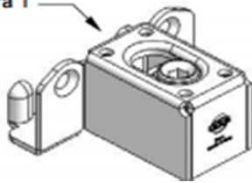
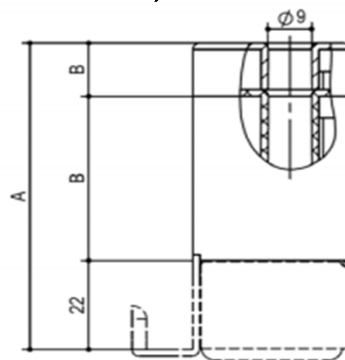

B		SK	
10	551.722.102		3000
23	551.722.103		1500
38	551.722.104		900

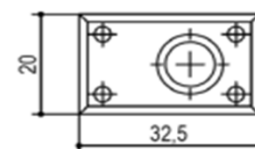

- Distanciador con agujero pasante para llave allen 4mm.





### 13.09 pie nivelador embutir REKORD

ITALIANA

medida	SK	
70	553.811.300	✓ 1/10
90	553.811.366	✓ 1/10

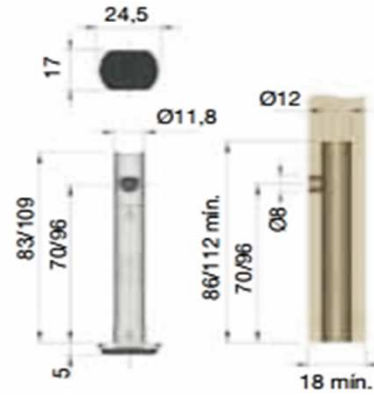

### pie nivelador embutir LUX

C	D=C+6	regulacion	SK	
24	30	15	551.197.022	p 400
32	38	15	551.197.024	p 300
52	58	25	551.197.026	p 200
70	78	25	553.197.023	p 150
100	106	25	553.197.020	p 100
120	126	25	551.197.025	p 100

Pata estabilizadora diametro 12 mm para costados de muebles a partir de 16mm. de espesor. Fácil montaje y regulación hasta 25mm. con llave Allen.

herrajes , patas y niveladores

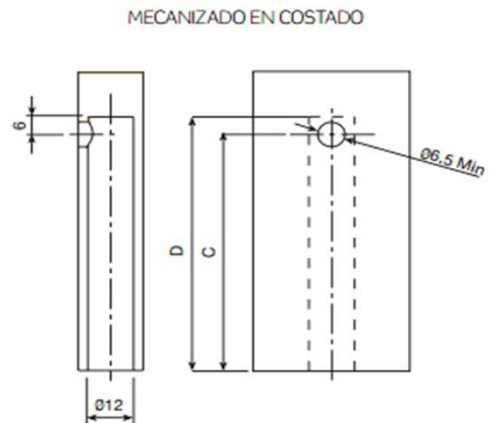
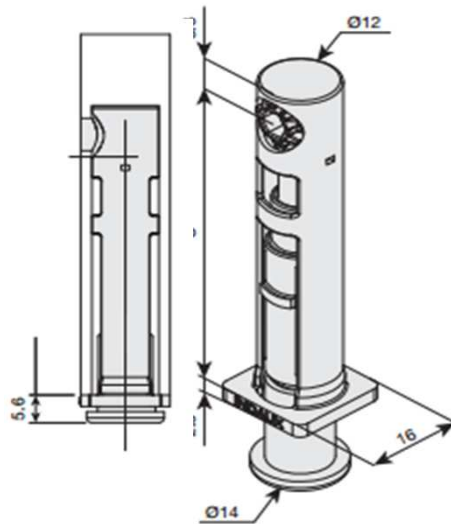

p= bajo pedido

✓= stock



13.09

**pie nivelador INTEGRATO FORTE**

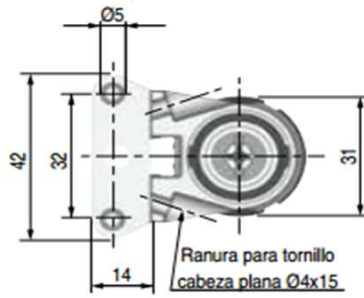
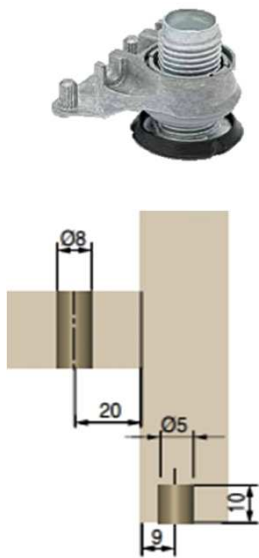

551.722.261



250

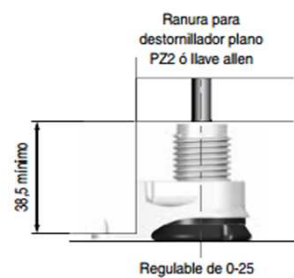
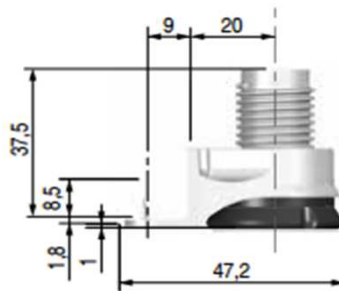
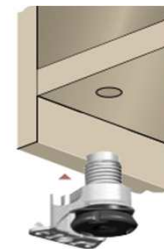

Adecuado para nivelar muebles pesados como armarios de puertas correderas, estanterías, módulos etc...  
 Regulable desde el interior del mueble con destornillador plano, PZ2 ó llave Allen de 6mm. atravesando el tablero practicado en el fondo del mueble.  
 Al pie nivelador INTEGRATO se le puede adaptar un espaciador que asegura una mejor distribución del peso del mueble sobre el pie nivelador.  
 El espaciador también desempeña una importante función de inclinación del nivelador en el caso de que el mueble lo requiera.  
 Regulable de 0-25mm.  
 Capacidad de carga 175 kilos por cada nivelador.  
 Probado y testado de acuerdo a los requerimientos de CATAS.

**DISTANCIADOR para pie nivelador INTEGRATO FORTE**

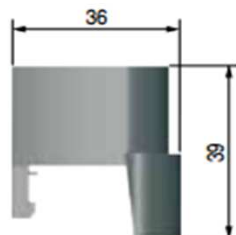

551.722.262



250

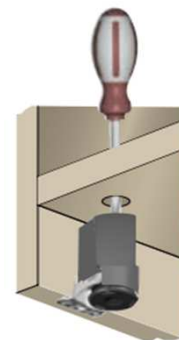





### 13.09 pie nivelador MODUL



reg.	carga	SK	
10mm	150 KG	553.811.300	250

- Regulable por medio de llave allen de 6mm.
- Montaje directo por bajo de costado con espiga Ø5mm. y con tirafondos por el lateral.

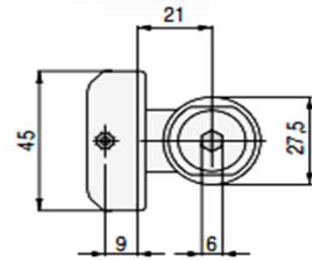
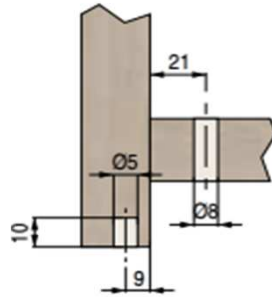
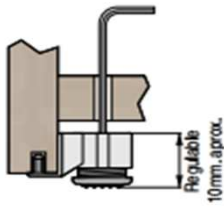
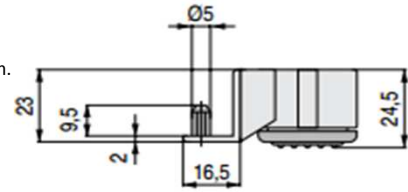

### pie nivelador embutir NEOX

reg.	SK	
10mm	551.722.168	500

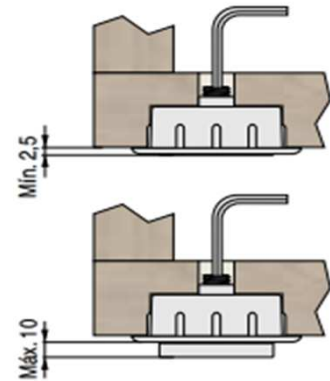
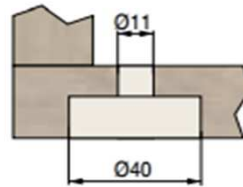
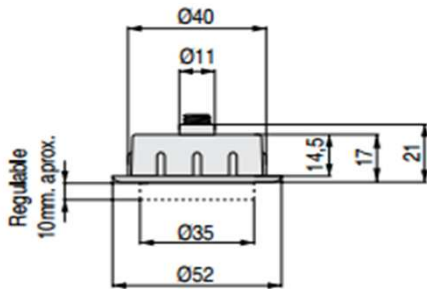





13.09

**pie nivelador con rueda pivotante JEY**

NYLON



Especialmente indicado para muebles que precisan ser desplazados de sitio. Desplazar el mueble por medio de las ruedas pivotantes, una vez en su sitio, regular y ajustar los niveladores para que las ruedas queden en el aire. Cuando necesiten mover el mueble aflojar los niveladores para que las ruedas queden en el suelo y así sucesivamente

Base con nivelador y rueda pivotante para fijar por medio de dos pivotes Ø8 y 2 tornillos. Rueda con banda de rodadura de goma. Antiruido. Cuerpo de nilón con fibra de vidrio. Alta resistencia. Con mano derecha y mano izquierda.

mano	carga		SK	
derecha	120 kg	551.722.525		100
izquierda	120 kg	551.722.526		100



banda rodadura de goma

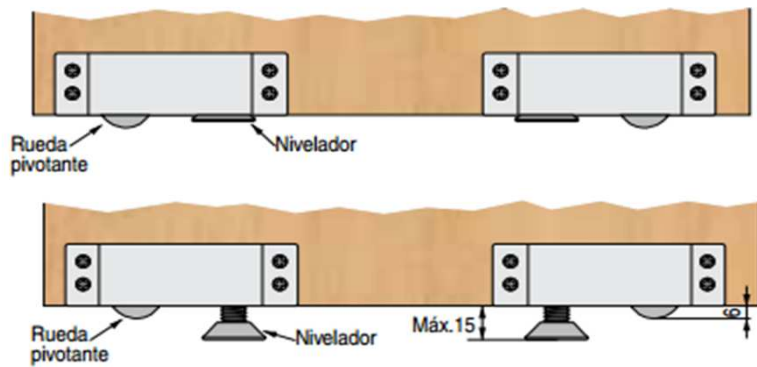
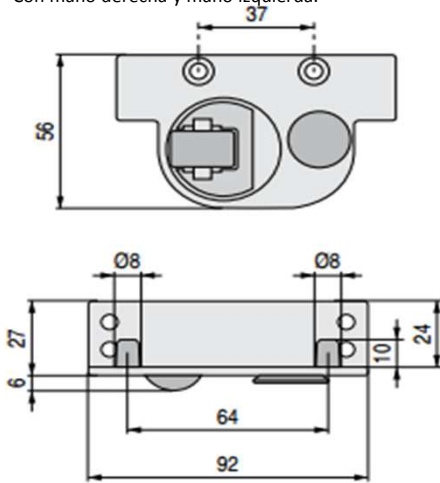

**pie nivelador MIX M10**



	SK	
551.722.223		500

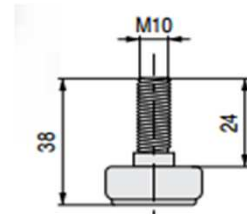
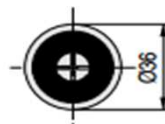

herrajes , patas y niveladores



i



13.09 pie nivelador MIX 2 M8



		SK	
--	--	----	--

551.722.724



500

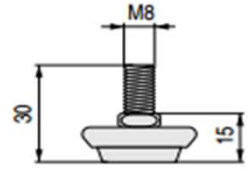

pie nivelador CONO M8



		SK	
--	--	----	--

551.722.723



500

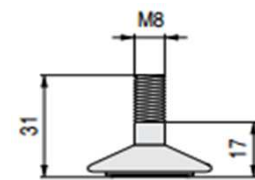

pie nivelador PROA con tuerca M8 y rotula



	H		SK	
--	---	--	----	--

20

551.722.912



1000

30

551.722.298



1000

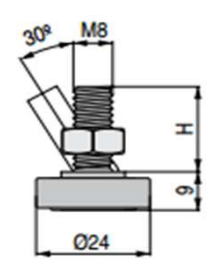

pie nivelador PROA M8 y rotula



		SK	
--	--	----	--

551.722.535



1/10

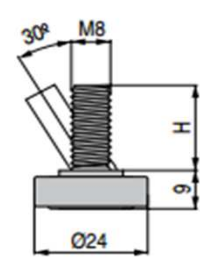





13.09

**pie nivelador TORNO M8**



acabado	SK	
chromo	551.722.140	 1000
gris	551.722.141	 1000

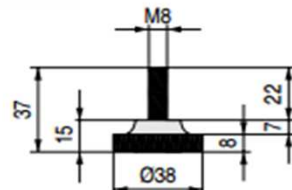

**pie nivelador VOLANTE M8**



L	A	SK	
65	40	551.722.747	 250
85	60	551.722.748	 250

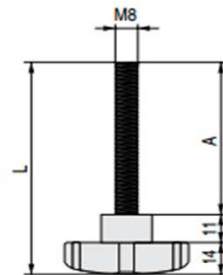

**pie nivelador NUBE M8**



SK	
551.722.420	 350

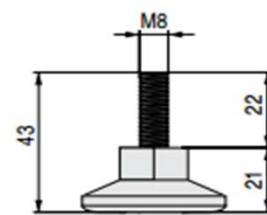
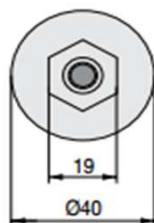

**pie nivelador CELIA M8**



SK	
551.722.745	 500

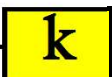
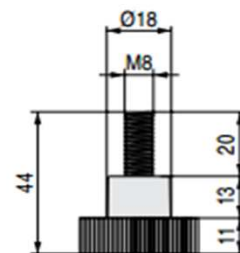
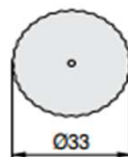



**13.09** pie nivelador DISCOLO



d		SK	
27	551.722.744		300
46	551.722.743		300

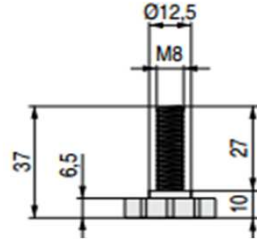

**pie nivelador PATA IKER**



d	chromo brillo	SK	
30	531.131.155		4/25

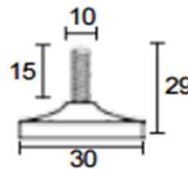

**pata mueble HULK con base oval**

PLASTICO

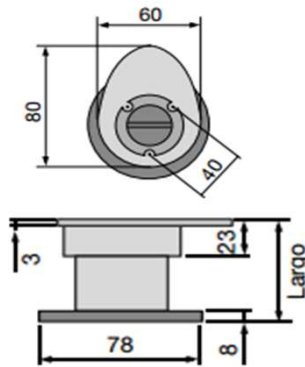

largo	negro	SK	
50 a 80	551.811.506		4/100

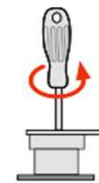

Permite regulación desde el interior del mueble

**pata mueble SANDY diametro 43 mm**

PLASTICO



largo	negro	SK	
35 a 50	551.811.023		1/200
65 a 100	551.811.250		1/200

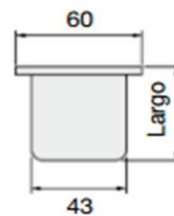

herrajes , patas y niveladores





13.10

**pata mesa regulable SILVANA 710 y 870 mm alt. diametro 60 y 80 mm**

ACERO

descripcion	diam.	blanco	negro	gris	amarillo	SK	
pata 71 cms	60	552.811.793	552.811.712	552.811.723	552.811.756	✓	1
pata 87 cms	60	552.811.841	552.811.815			✓	1

descripcion	diam.	cromo	efecto inox	cromo look	aluminio	SK	
pata 71 cms	60	552.811.771	552.811.782	552.811.456	552.811.793	✓	1
pata 87 cms	60	552.811.826	552.811.830	552.811.460	552.811.841	✓	1
pata 87 cms	80	552.811.874	552.811.885	552.811.471		✓	1

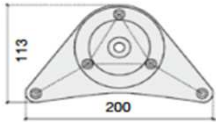

Regulable



descripcion	diam.	negro	inox	SK	
rueda	60	552.811.456	552.811.793	✓	1
adaptable	60	552.811.460	552.811.841	✓	1
adaptable	80	552.811.471		✓	1

**Rueda adaptable**

Con freno. Permite hacer un ala o mesa móvil. Adaptable a la pata SILVANA excepto al acabado Aluminio Rayado.

**Adaptable a sobres de cristal**

Adaptable a cualquier modelo de pata para fijarlo a sobres de mesa de cristal.



Cromo

Gris

Amarillo

Negro

Blanco

Aluminio

 Cromo  
Look

 Efecto  
Inox

herrajes , patas y niveladores



a

✓ = stock

p = bajo pedido



### 13.10 pata mesa regulable EKO 710 mm alt. diametro 60 mm

ACERO

alt.	blanco	chromo brillo	chromo look	negro	SK	
710	553.811.412	553.811.434	553.811.515	553.811.401	✓	1
830	553.131.011	553.131.013	553.131.014	553.131.012		

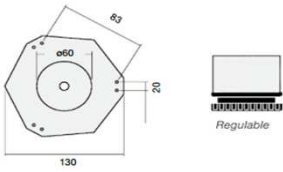

La base es independiente de la pata, permitiendo desmontarla sin necesidad de desatornillarla del sobre.  
Regulable hasta una altura máxima de 3,5 cms +.

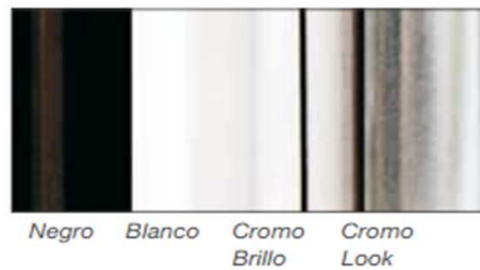

### pata mesa regulable EKO 710 mm alt. diametro 80 mm

ACERO

niquel satinado	blanco	chromo brillo	gris ral 9006	negro	SK	
553.131.009	553.313.006	553.131.008	553.131.010	553.131.007	✓	1

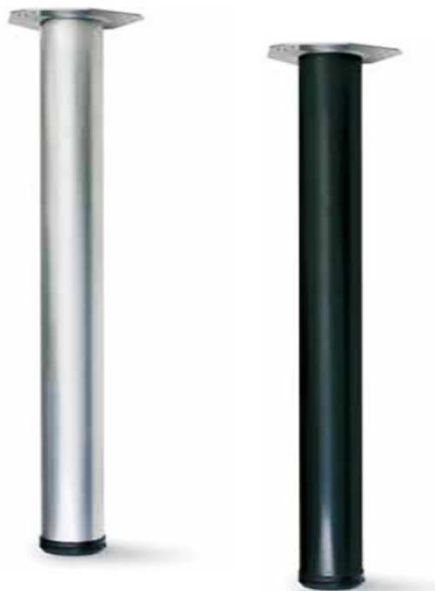
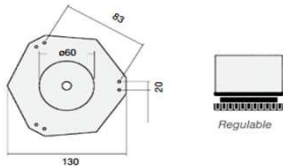

La base es independiente de la pata, permitiendo desmontarla sin necesidad de desatornillarla del sobre.  
Regulable hasta una altura máxima de 3,5 cms +.



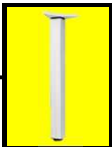

13.10

**pata mesa regulable CIRO 710 alt. 60X60**

ALUMINIO

aluminio	chromo look	SK	
553.811.526	553.811.843	✓	1

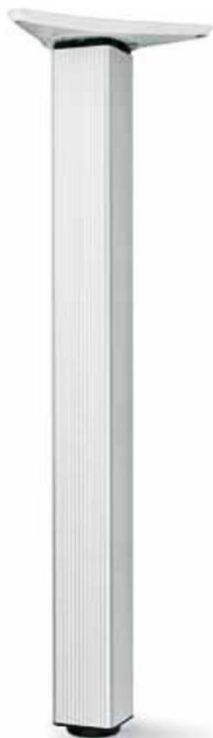

La base es independiente de la pata, permitiendo desmontarla sin necesidad de desatornillarla del sobre.  
Regulable hasta una altura máxima de 74'5 cms.

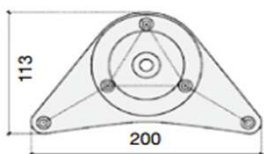

Altura regulable



Aluminio Cromo Look

**pata mesa extensible 710 a 1100 mm KATEL diametro 60 mm**

ACERO

chromo brillo	chromo look	SK	
552.811.605	552.811.160	✓	1



Cromo Brillo

Cromo Look.







### 13.10 pata mesa regulable LUCA 710 y 870 mm alt. 80x80 mm

ACERO

largo	costado	chromo look	SK	
710 mm	80 mm	553.811.182	✓	1
787 mm	80 mm	553.811.193	✓	1

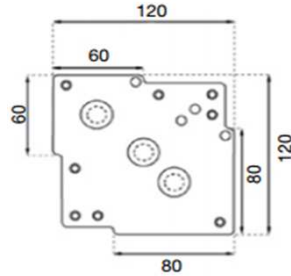

Regulable

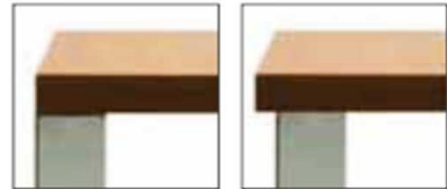

La base permite instalarse centrada o a ras de la pata.

### pata mesa extensible 710 a 910 mm ROOM diametro 60 mm

ACERO

ral 9006 gris	SK	
552.131.019	✓	1

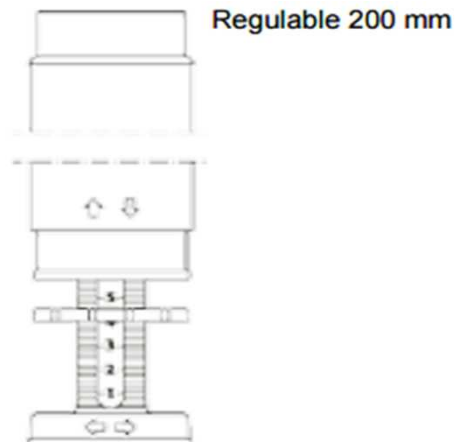



13.10

**pata mesa regulable EKO 810 alt. diametro 80 mm**

ALUMINIO

	cromo	efecto inox	SK	
1 juego 4 patas	553.298.514	553.298.516	✓	1

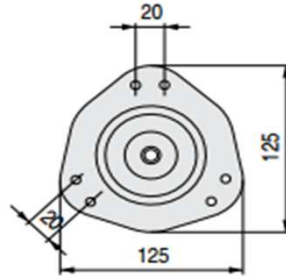

Soporte en hierro acabado zincado



REGULABLE  
Máx. 10mm.

**pata mesa regulable FUM 690 a 940 mm diametro 80 mm**

ACERO

	cromo	SK	
	553.298.928	✓	1

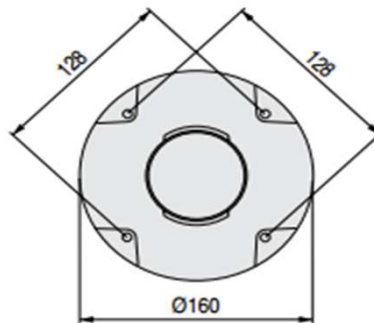

Soporte en plástico acabado negro

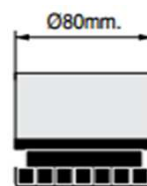

REGULABLE  
Máx. 10mm.





### 13.10 pata mesa regulable CELSO 710 mm alt. 50x50 mm

ACERO

cromo look	SK	
553.811.401	✓	1



Altura mínima de 71 cm.  
 Permite una regulación de 15  
 Diámetro del regulador de 75

La base es independiente de la pata, permitiendo desmontarla sin necesidad de desatornillarla del sobre

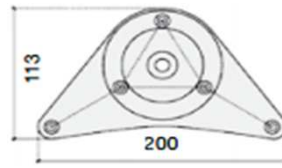

### peana de mesa regulable YANN 690 A 870 mm alt. Diametro 120 mm

ACERO

cromo brillo	cromo look	SK	
531.811.896	531.811.955	✓	1

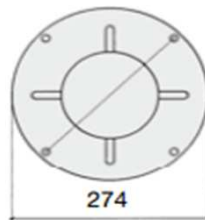
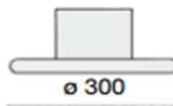

Cromo Brillo

Efecto Inox.



Regulable de 69 a 87 cm.

herrajes , patas y niveladores



f



13.10

**peana de mesa BRAND 740 y 1100 alt. diametro 75 mm**

ACERO/HIERRO

	medida	H	L	material	inox brillo	inox mate	SK	
columna	d:75	1100	1070	acero		553.298.124		1
columna	d:75	1100	1070	acero	553.298.125			1
columna	d:75	740	710	acero		553.298.122		1
columna	d:75	740	710	acero	553.298.123			1
base	d:580			acero		553.298.106		1
base	d:580			acero	553.298.107			1
cruceta	455x455			hierro negro	553.298.134			1

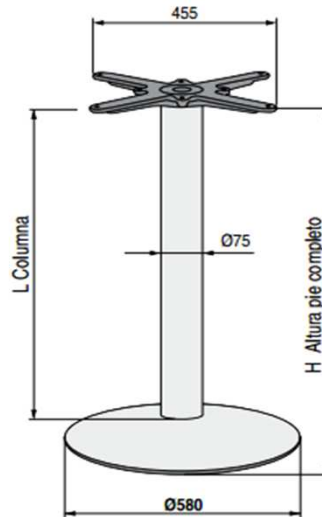

Base redonda plana Ø580, con 6 niveladores.  
 Espesor 17mm. (nivelador incluido)  
 Columna Ø75.  
 Dos medidas de longitud: 1070mm. y 710mm.  
 Cruceta 455x455mm.  
 Espesor 15mm.  
 PESO CONJUNTO 1100 MM 20,5 KG.  
 PESO CONJUNTO 740 MM 20 KG.

Para pedir un pie completo solicitar:  
 1 Columna (ver altura y acabado)  
 1 Base (ver acabado)  
 1 Cruceta

**peana de mesa ZIMA 740 y 1100 alt. diametro 75 mm**

ACERO/HIERRO

	medida	H	L	material	inox brillo	inox mate	SK	
columna	80x80	1100	1070	acero		553.298.133		1
columna	80x80	1100	1070	acero	553.298.132			1
columna	80x80	740	710	acero		553.298.131		1
columna	80x80	740	710	acero	553.298.130			1
base	470x470			acero		553.298.110		1
base	470x470			acero	553.298.111			1
cruceta	455x455			hierro negro	553.298.134			1

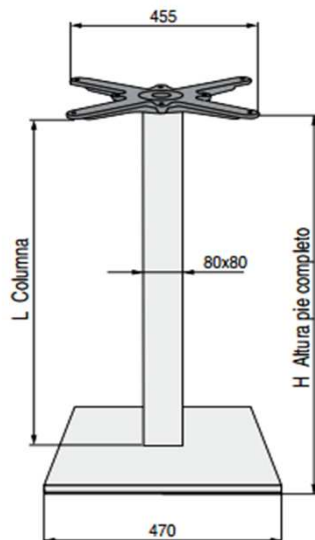

Base cuadrada plana 470x470 con 6 niveladores.  
 Espesor 17mm. (nivelador incluido)  
 Columna 80x80.  
 Dos medidas de longitud: 1070mm. y 710mm.  
 Cruceta 455x455mm.  
 Espesor 15mm.  
 PESO CONJUNTO 1100 MM 17,5 KG.  
 PESO CONJUNTO 740 MM 17 KG.

Para pedir un pie completo solicitar:  
 1 Columna (ver altura y acabado)  
 1 Base (ver acabado)  
 1 Cruceta

**13.10** peana de mesa TORPEDO 740 y 1100 alt. diametro 75 mm

ACERO/HIERRO

	medida	H	L	material	inox brillo	inox mate	SK	
columna	d:75	1100	1000	acero		553.298.124		1
columna	d:75	1100	1000	acero	553.298.125			1
columna	d:75	740	640	acero		553.298.122		1
columna	d:75	740	640	acero	553.298.123			1
base	d:500			acero		553.298.106		1
base	d:500			acero	553.298.107			1
cruceta	455x455			hierro negro	553.298.134			1

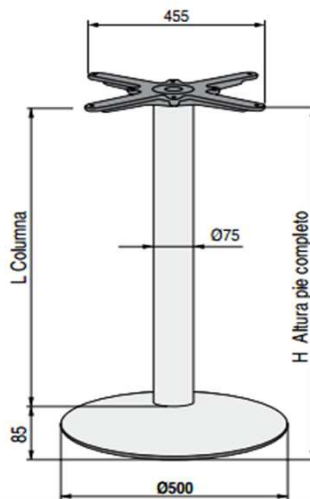

Base redonda plana Ø500, con pesa 275 MM para el interior de la base.  
 Espesor 20 mm.  
 Columna Ø75.  
 Dos medidas de longitud: 1000mm. y 640mm.  
 Cruceta 455x455mm.  
 Espesor 15mm.  
 PESO CONJUNTO 1100 MM 16 kg.  
 PESO CONJUNTO 740 MM 15,5 kg.  
 Para pedir un pie completo solicitar:  
 1 Columna (ver altura y acabado)  
 1 Base (ver acabado)  
 1 Cruceta

**peana de mesa EDWIN 740 mm alt. Diametro 50 mm**

ACERO

chromo look	SK	
		1
553.811.821		1



Apta para mesas con una pata central.  
 Muy estable

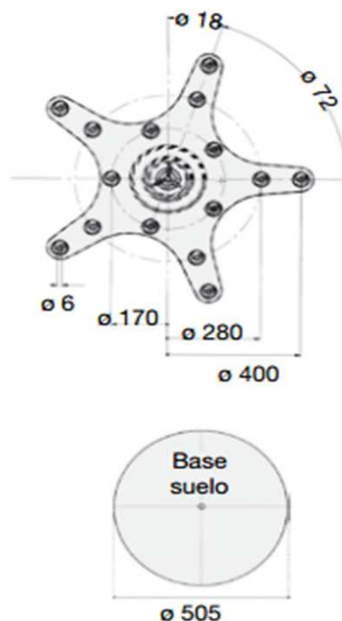





**13.10**

**pata de mesa abatible CONF 710 mm alt. diametro50 mm**

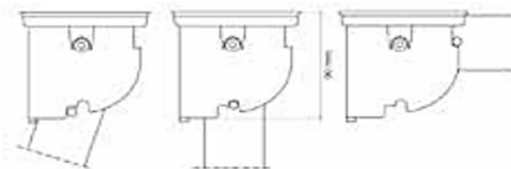
	gris ral 9006	SK	
710x50	531.131.017	✓	1



**pata mesa abatible regulable KASER 710 a 910 mm alt. diametro 50 mm**

	gris ral 9006	SK	
	531.131.018	✓	1

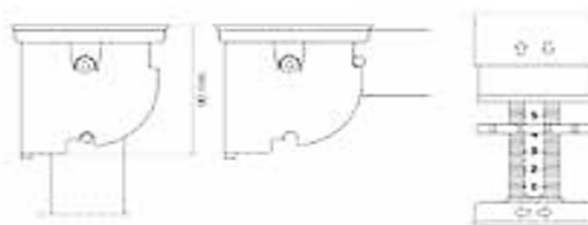

 herrajes , patas y niveladores



patas mesa

**13.10** pata de mesa abatible PLAN 710 mm alt. 50x50 mm

	gris ral 9006	SK	
710x50x50	531.131.016	✓	1
		✓	

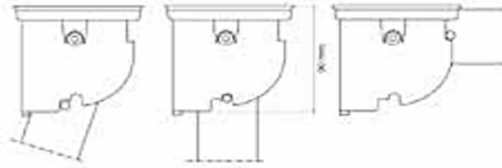
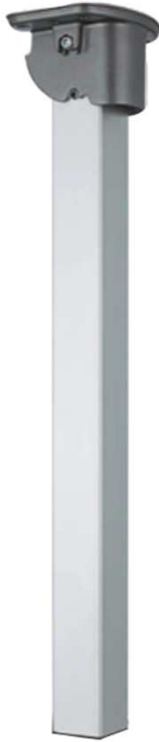

**pata de mesa abatible JOY 710 mm alt. Diametro 50 mm**

ACERO

aluminio	SK	
552.811.530	✓	1

herrajes , patas y niveladores



Detalle de acabado

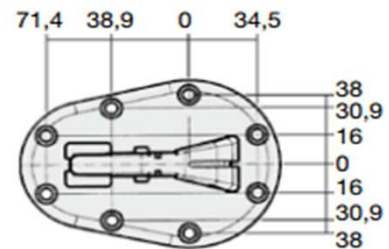

Regulable



Posición plegada  
Sistema CLIP, en dos posiciones.



p= bajo pedido

✓= stock







**13.10**

**juego dos patas plegables FLAMING 710 mm alt.**

ACERO

**chromo brillo** **SK**   
531.811.576  1

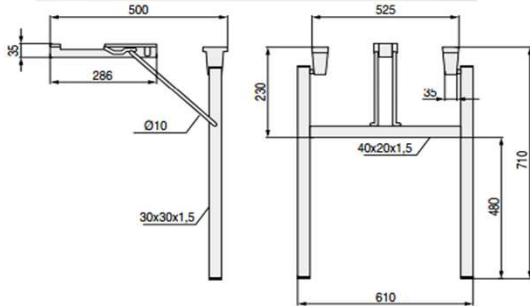
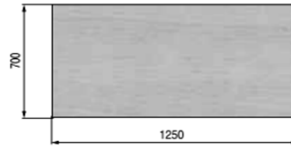

Dimensiones mínimas del Tablero



- Muy fácil de instalar - Sistema plegable y apilable
- Medida mínima de mesa: 125 x 70 cms.
- El código dispone de todos los accesorios necesarios para el montaje de una mesa.

**juego dos patas plegables FLAMINGTWO 710 mm alt.**

ACERO

**chromo brillo** **SK**   
531.298.062  1

Dimensiones mínimas del Tablero

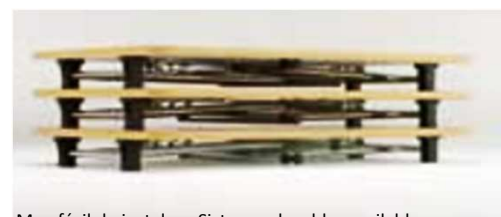
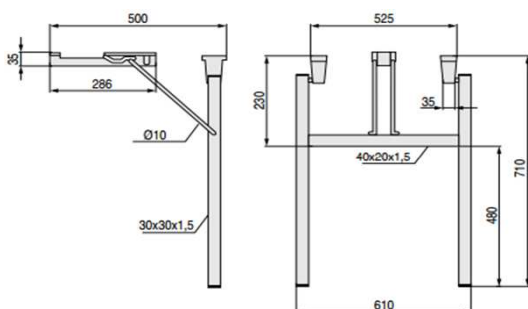
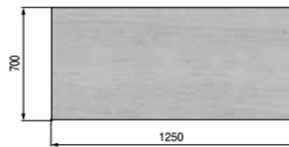

- Muy fácil de instalar - Sistema plegable y apilable
- Medida mínima de mesa: 125 x 70 cms.
- El código dispone de todos los accesorios necesarios para el montaje de una mesa.

herrajes , patas y niveladores



**k**



### 13.10 set union mesa CONET

PLASTICO

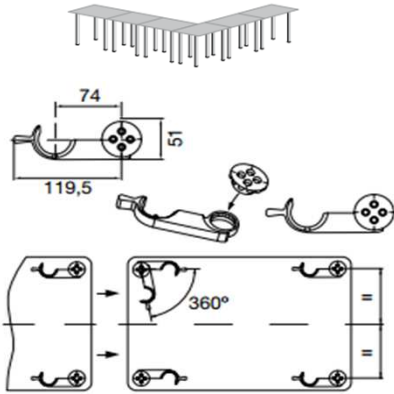

contenido del set:



negro	SK	
531.811.580	✓	1

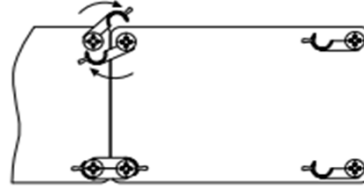

Funcionamiento:



### estructura ARCO porteria de 71 y 87 cms tubo 60x20

ACERO

alto	ancho	efecto inox	SK	
71 cms	80 cms	531.811.554	✓	1
87 cms	80 cms	531.811.565	✓	1

herrajes , patas y niveladores



**pata regulable PAULA 40x40 mm**

ALUMINIO/abs

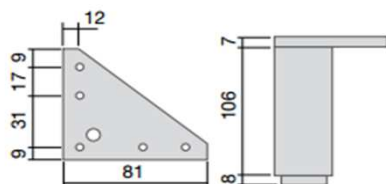

largo	alum.mate	alum.brillo	SK	
80	551.811.381	551.811.392	✓	4
100	551.811.403	551.811.414	✓	4
120	551.811.425		✓	4
150	551.811.436	551.811.440	✓	4
200	551.811.451		✓	4

**pata regulable AITANA diametro 40 mm**

ALUMINIO



medida	chromo mate	SK	
90 a 120	551.811.364	✓	1
160 a 190	551.811.390	✓	1

**pata regulable con base MARIOLA**

ABS



medida	chromo mate	SK	
largo 125	551.811.600	✓	1

**pata regulable AIDA diametro 50 mm**

ACERO/ZAMAK



		efecto inox	zincado	SK	
1	pata largo 180 a 210	5311.811.003		✓	1
2	base		5311.811.014	✓	1
3	tornillo		5311.811.025	✓	1



### 13.11 pata fija CLAUDIA 40x40 mm

ACERO

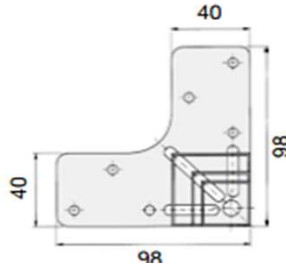

largo	chromo brillo	chromo look	SK	
100	551.811.865	551.811.740	✓	1
120	551.811.876	551.811.751	✓	1
150	551.811.880	551.811.762	✓	1
200	551.811.891	551.811.773	✓	1
250	551.811.902	551.811.784	✓	1
300	551.811.913	551.811.795	✓	1

### pata regulable MAGIC

ZAMAK

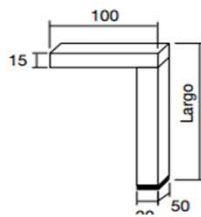

Múltiples tipos de montaje:



largo	chromo brillo	chromo look	SK	
100	551.811.020	551.811.086	✓	1
120	551.811.031	551.811.090	✓	1
150	551.811.042	551.811.101	✓	1
200	551.811.053	551.811.112	✓	1
250	551.811.064	551.811.123	✓	1
	551.811.075	551.811.134	✓	1

### pata regulable FONDA

ZAMAK



largo	B	C	chromo brillo	efec.inox mate	SK	
100	80	44	531.811.602	531.811.613	✓	1
150	80	44	531.811.624	531.811.635	✓	1
200	100	64	531.811.646	531.811.650	✓	1

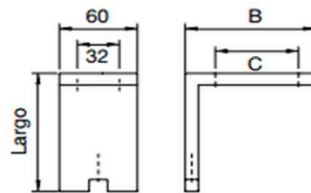

### pata fija AITOR

ZAMAK



largo	chromo brillo	chromo look	SK	
92	551.811.714	551.811.703	✓	4

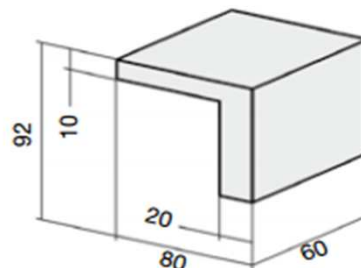

herrajes , patas y niveladores



b

**pata fija CITRA**

ABS

largo	chromo brillo	chromo look	SK	
30	551.811.005	551.811.994	✓	4

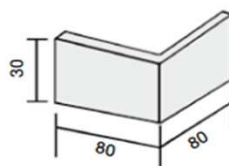

**pata fija PASTRANI**

ACERO

D	A	B	C	L	chromo	SK	
35	100	65	39	135	511.298.550	✓	1
35	100	65	39	170	511.298.554	✓	1
35	100	65	39	225	511.298.548	✓	1
35	150	65	39	280	511.298.553	✓	1
35	150	65	39	305	511.298.555	✓	1
40	100	70	44	225	511.298.555	✓	1
40	100	70	44	280	511.298.555	✓	1
50	100	75	54	225	511.298.555	✓	1

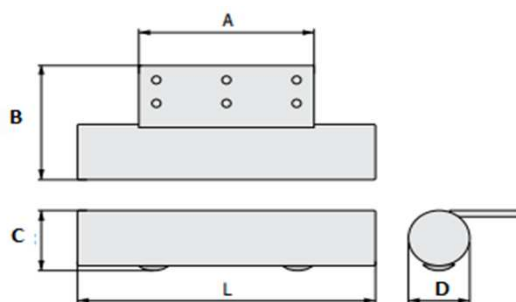

**pata fija NIZA**

ACERO

L	chromo	efecto inox	SK	
225	511.298.928	511.298.929	✓	1
305	511.298.968		✓	1

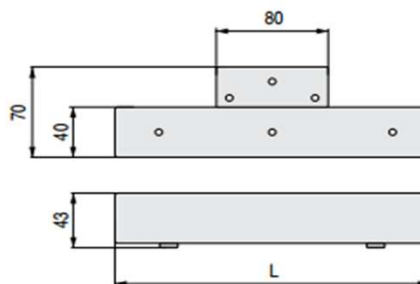



### 13.11 pata IKER redonda diametro 30 mm

ACERO



A	blanco	gris	negro	niquel sat.	SK	
100	531.131.106	531.131.112	531.131.118	531.131.124	✓	4
150	531.131.107	531.131.113	531.131.119	531.131.125	✓	4
250	531.131.108	531.131.114	531.131.120	531.131.126	✓	4
400	531.131.109	531.131.115	531.131.121	531.131.127	✓	4
700	531.131.110	531.131.116	531.131.122	531.131.128	✓	4
800	531.131.111	531.131.117	531.131.123	531.131.129	✓	4
		nivelador M10x29 cromo brillo		531.131.155	✓	4/25

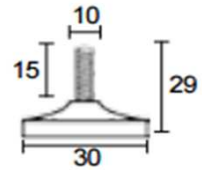
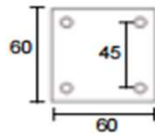

### pata IKER cuadrada 25x25 mm

ACERO



A	blanco	gris	negro	niquel sat.	SK	
100	531.131.130	531.131.136	531.131.142	531.131.148	✓	4
150	531.131.131	531.131.137	531.131.143	531.131.149	✓	4
250	531.131.132	531.131.138	531.131.144	531.131.150	✓	4
400	531.131.133	531.131.139	531.131.145	531.131.151	✓	4
700	531.131.134	531.131.140	531.131.146	531.131.152	✓	4
800	531.131.135	531.131.141	531.131.147	531.131.153	✓	4
		nivelador M10x29 cromo brillo		531.131.155	✓	4/25

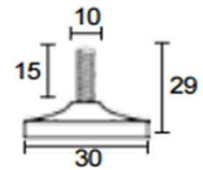
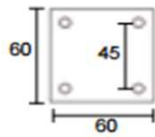







13.11

**pata KAD plastico negro recubierta con lamina de acero inox brillo**

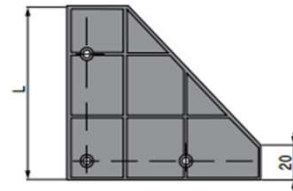
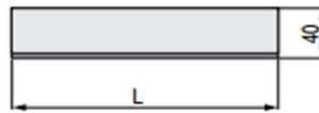
PLASTICO



L	inox brillo	SK	
120	511.298.754	✓	4
140	511.298.755	✓	4

**pata CORNER plastico negro recubierta con lamina de acero inox brillo**

PLASTICO

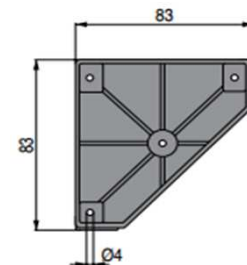
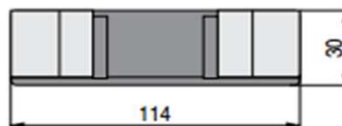

inox brillo	SK	
511.298.375	✓	4

**pata fija con base PILAR**

ALUMINIO

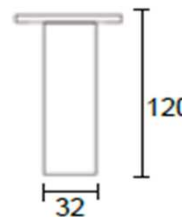
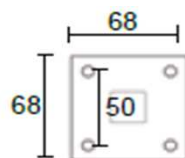

medida	aluminio	SK	
32X32X120 mm alt.	551.131.200	✓	24

**pata fija PT1**

ALUMINIO

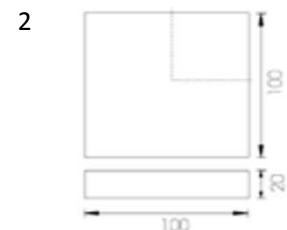
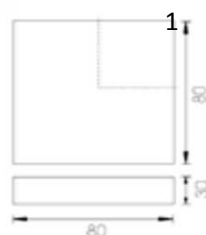

medidas	aluminio	SK	
1 80x80x30 alt.	551.131.212	✓	4
2 100x100x20 alt.	551.131.213	✓	4

herrajes , patas y niveladores



✓ = stock

p = bajo pedido





# 13.11 pata fija LEIRE 40x40 mm

PLASTICO



largo	chromo brillo	gris ral 9006	SK	
100	511.298.099	511.298.100	✓	1
80	511.298.101	511.298.102	✓	1

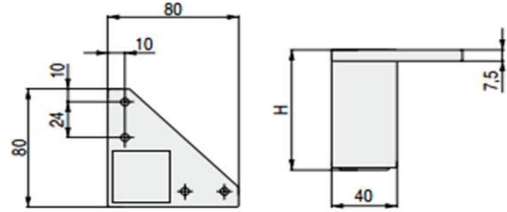



13.12

**pata mueble THEO con base larga y corta**

PLASTICO



Base Corta

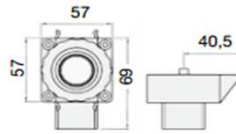

Base Larga

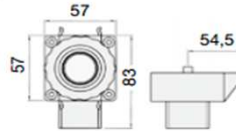

base	largo	negro	SK	
corta	100 a 140	551.811.145	✓	4/200
corta	140 a 190	551.811.961	✓	4/200
larga	100 a 140	551.811.156	✓	4/200
larga	140 a 190	551.811.572	✓	4/200

Cabeza y tubo desmontables para un mejor transporte de los muebles.  
Con tetón expansivo de 13 mm. Con refuerzo para el lateral del mueble  
PINZA MOD. THEO

**pata mueble BYP con teton 13 mm**

PLASTICO

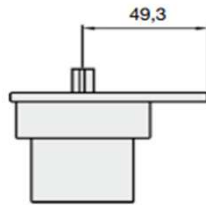

medida	negro	SK	
140 a 210	551.811.806	✓	4/200

Cabeza y tubo desmontables para un mejor transporte de los muebles.  
Con tetón expansivo de 13 mm.  
Con refuerzo para el lateral del mueble.  
PINZA MOD. KIT

**pata mueble KIT con base oval y tornillo plastico**

PLASTICO

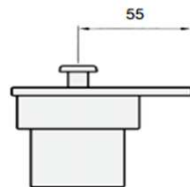

medida	negro	SK	
80 a 105	551.811.270	✓	4/200
130 a 200	551.811.266	✓	4/180

Cabeza y tubo desmontables para un mejor transporte de los muebles.  
La cabeza puede fijarse en el mueble mediante tornillos por la base sin necesidad de perforar el tornillo central.  
PINZA MOD. KIT

**pata mueble BENTO con tornillo**

PLASTICO



tornillo	medida	negro	SK	
plastico	83 a 130	551.811.465	✓	4/200
plastico	130 a 200	551.131.302	✓	48
zamak	130 a 200	551.131.303	✓	48

PINZA MOD. KIT





### 13.12 grapa zocalo THEO

PLASTICO



Para el montaje en la pata THEO.

tipo de zocalo	negro	SK	
madera	202.811.292	✓	25/400
PVC paso estrecho	202.811.950	✓	25/400
ALUMINIO paso ancho	202.811.946	✓	25/400

### grapa zocalo KIT con desplazamiento lateral

PLASTICO

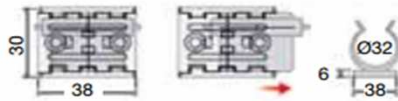

tipo de zocalo	negro	SK	
madera	202.811.810	✓	25/500
PVC paso estrecho	202.811.054	✓	25/500
ALUMINIO paso ancho	202.811.145	✓	25/500



Para el montaje en la pata tubo redondo.

### grapa presion zocalo 16 mm INES

ACERO



beige	SK	
202.811.515	✓	1

### grapa presion zocalo 12 a 19 mm GALA

ACERO

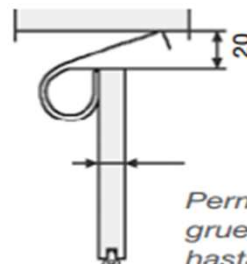

zincado	SK	
202.811.014	✓	4





13.12

**pata mueble HULK con base oval**

PLASTICO

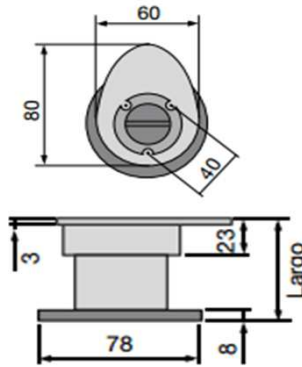

largo	negro	SK	
50 a 80	551.811.506	✓	4/100

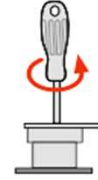

Permite regulación desde el interior del mueble

**pata mueble SANDY diametro 43 mm**

PLASTICO

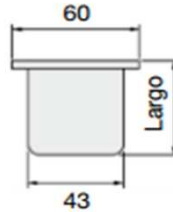

largo	negro	SK	
35 a 50	551.811.023	✓	1/200
65 a 100	551.811.250	✓	1/200

**pata mueble TORRE con teton 13 mm**

PLASTICO

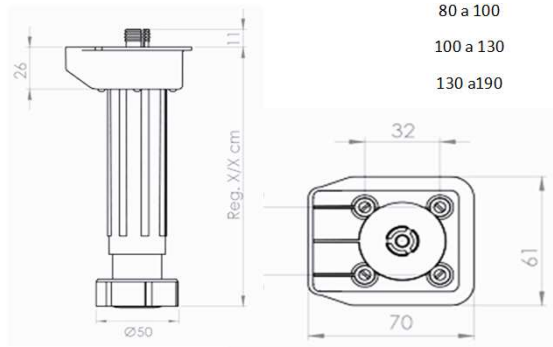

largo	negro	SK	
80 a 100	531.928.107	✓	100
100 a 130	531.928.607	✓	100
130 a 190	531.928.707	✓	100

PINZA MOD. KIT

**pata mueble PICOLA con teton 13 mm**

PLASTICO

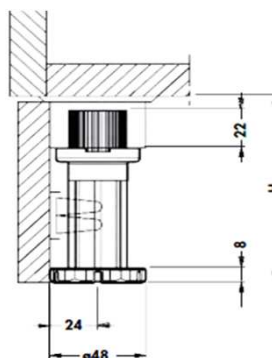

largo	negro	SK	
50 a 80	531.928.407	✓	4/100



herrajes , patas y niveladores





### 13.12 pata mueble UNICO

PLASTICO

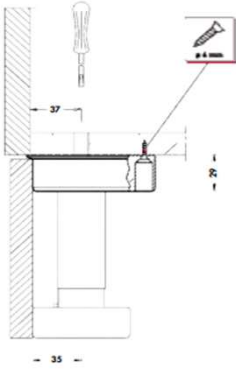

Base Pata Único Atornillar

descripcion	largo	negro	SK	
pata	100 a 130	531.928.408	✓	4/200
pata	150 a 180	531.928.409	✓	4/200
base atornillar		531.928.410	✓	4/400
e 3 teton 12mm		531.928.411	✓	4/400

Posibilidad de fijación al suelo mediante tirafondos o tres espigas expansivas de 12 mm..  
Fabricado en ABS y polipropileno con certificación LGA.  
Regulación -15 mm / +30 mm.  
Posibilidad de regulación desde el interior del módulo o desde la parte inferior estriada.

PINZA MOD. KIT

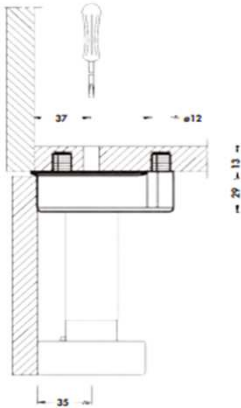

Base Pata Único 3 Espigas



### pata mueble UNICO

PLASTICO/ZAMAK/ACERO

descripcion	largo	negro	SK	
pata	100 a 170	531.928.096	✓	4/100
base teton 15mm		531.928.097	✓	4/400

Fabricado en ABS, zamak y acero.  
Posibilidad de regulación desde el interior del módulo o desde la parte estriada de la pata.  
Gran capacidad de carga.  
Regulación desde -5 mm. hasta 70 mm. dependiendo del posicionamiento de la pata.  
Diámetro de la espiga expansible 15 mm.

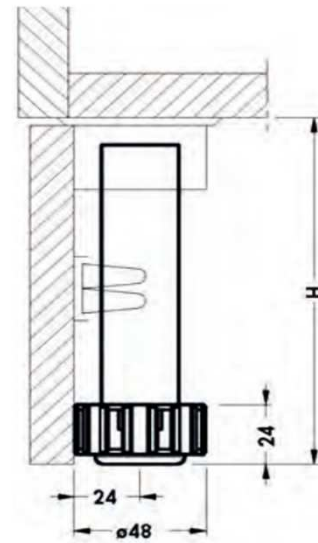





13.13

**deslizante metalico 20 mm**

PLASTICO/ACERO



diámetro	altura H	marron/niquel	SK	
20	9	551.811.263	✓	50/200
25	9,5	551.298.953		200
30	10	551.298.954		200

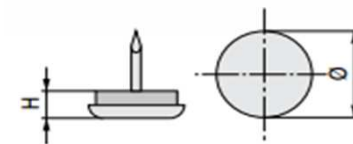

**deslizante plastico 14,5 y 17 mm**

PLASTICO/ACERO



diámetro	blanco	marron	SK	
14,5	551.811.166	551.811.155	✓	100
17,5	551.811.252	551.811.274	✓	100

**deslizante teflon 22 mm**

TEFLON/ACERO







gris	SK	
551.811.730	✓	100

Gran poder de deslizamiento con mínimo desgaste

**deslizante fieltro 20 mm**

PLASTICO/FIELTRO/ACERO



diámetro	altura H	marron	SK	
17	7,5	551.298.511		200
20	7,5	551.811.726	✓	100
24	8	551.298.513		200
25	8	551.298.514		200

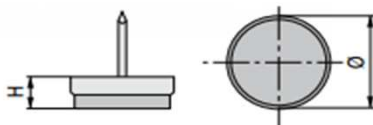



### 13.13 tope una punta en tiras

PLASTICO/ACERO

gris ral 9006	SK	
551.722.256	✓	5000

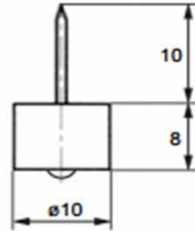

En tiras de 12 topes , color marron consultar

### tope dos puntas

PLASTICO/ACERO

negro	marron	SK	
551.722.302	551.722.306	✓	1000

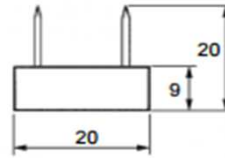

### deslizante ZOLETA MD

PLASTICO

negro	SK	
551.722.102	✓	5000

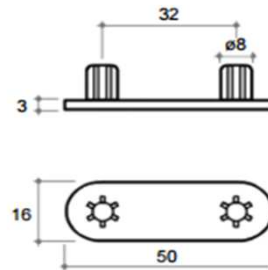

### deslizante ovalado a tiras

PLASTICO

marron	SK	
551.722.106	✓	4

En tiras de 14 deslizantes , color blanco consultar.

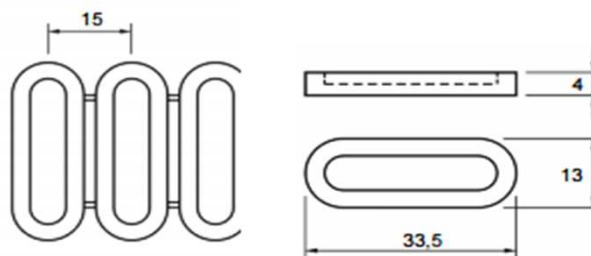

herrajes , patas y niveladores



d





13.13

**tope 0 sin punta**

PLASTICO

marron	negro	SK	
551.722.006	551.722.002	✓	1000

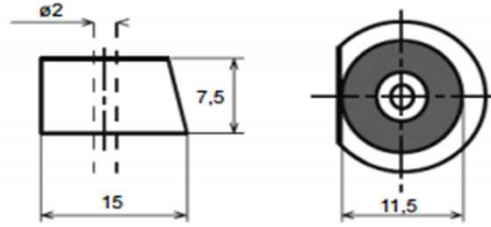

**deslizante FIELTRO adhesivo 5,5 mm**

FIELTRO





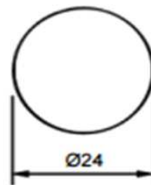



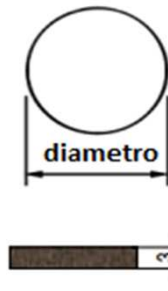

marron	SK	
551.722.806	✓	100



**deslizante FIELTRO adhesivo 3 mm**

FIELTRO







diametro	blanco	marron	SK	
16		551.298.815		50
18	551.298.821	551.298.820		40
22		551.298.822		40
28	551.298.833	551.298.823		24
32		551.298.824		14
36		551.298.825		18
45		551.298.826		10

**deslizante FIELTRO cuadrado adhesivo 3 mm**

FIELTRO



medida	marron	SK	
25x25	551.298.841		32
35x35	551.298.842		12
45x45	551.298.843		10

**CUÑA madera**

PINO

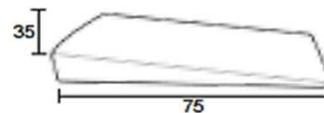

medida	marron	SK	
75x35	552.131.575		100

herrajes , patas y niveladores





### 13.13 deslizante PISA metalico para tablero de 16 mm

ACERO

bicromatado	SK	
551.298.162		2000



Deslizamiento suave.  
Facilidad y rapidez en movimiento de muebles evitando golpes en los cantos.

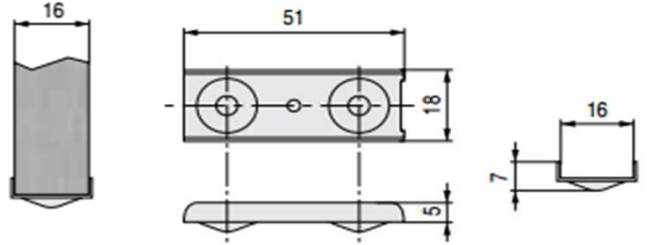

### deslizante ZEN embutir taladro 5 mm

PLASTICO

negro	SK	
551.298.242		5000

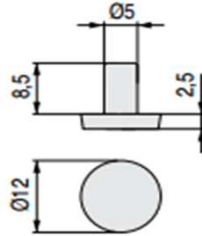

Con espiga para montaje directo de  $\varnothing 5$ mm.  
Ideal como deslizante para patas metálicas, muebles u otros.

### deslizante ZEN embutir taladro 8 mm

PLASTICO

negro	SK	
551.298.911		10000

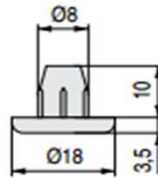

herrajes , patas y niveladores

### deslizante ZEN rectangular embutir taladro 5 mm

PLASTICO

negro	SK	
551.298.243		5000



Con espiga para montaje directo de  $\varnothing 5$ mm.  
Ideal como deslizante para patas metálicas, muebles u otros.

