



14.10

**pomo puerta bola entrada**



referencia	medidas	entrada	acabado	SK	
933.131.153	d:50	60-70	laton pul.	✓	1
933.131.154	d:50	60-70	inox mate	✓	1
933.131.161	d:50	60-70	blanco	✓	1



Llave - Muletilla  
Bloqueo y desbloqueo en ambos lados

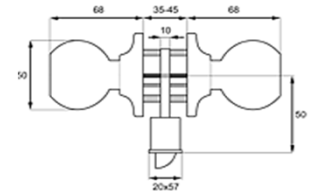

**pomo puerta bola baño**



referencia	medidas	entrada	acabado	SK	
933.131.155	d:50	60-70	laton pul.	✓	1
933.131.156	d:50	60-70	inox mate	✓	1
933.131.162	d:50	60-70	blanco	✓	1



Desbloqueo - Condena  
Interior con muletilla para bloqueo y exterior con desbloqueo de seguridad

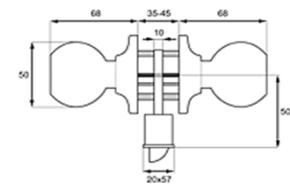

**pomo puerta bola hotel**



referencia	medidas	entrada	acabado	SK	
933.131.157	d:50	60-70	laton pul.	✓	1
933.131.158	d:50	60-70	inox mate	✓	1
933.131.163	d:50	60-70	blanco	✓	1



Llave - Libre  
Apertura exterior con llave. Interior siempre libre

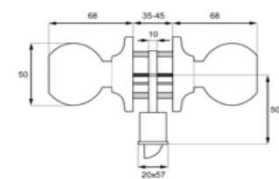

**pomo puerta paso**



referencia	medidas	entrada	acabado	SK	
933.131.159	d:50	60-70	laton pul.	✓	1
933.131.160	d:50	60-70	inox mate	✓	1
933.131.161	d:50	60-70	blanco	✓	1



Libre - Libre  
No se bloquea nunca

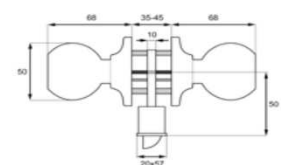



14.10 llave en bruto pomo bola

referencia	acabado	SK	
933.131.165	zincado	✓	50



pomo 3500

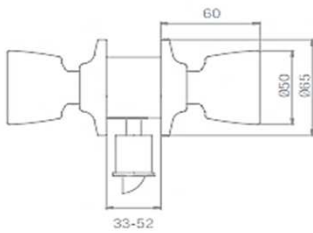

TESA

item	referencia	medidas	tipo	acabado	SK	
3505	933.811.843	d:65	puerta de paso	laton mate	✓	1
3503	933.811.854	d:65	baño/condena	laton mate	✓	1
3500	933.811.865	d:65	entrada	laton mate	✓	1
3501	933.811.491	d:65	solo llave/condenar	laton mate	p	1
3502	933.811.502	d:65	porteria/sin cond.	laton mate	p	1
3505	933.811.876	d:65	puerta de paso	chromo mate	✓	1
3503	933.811.880	d:65	baño/condena	chromo mate	✓	1
3500	933.811.891	d:65	entrada	chromo mate	✓	1
3501	933.811.513	d:65	solo llave/condenar	chromo mate	p	1
3502	933.811.524	d:65	porteria/sin cond.	chromo mate	p	1

Sistema Cuadradillo



item	referencia	medidas	tipo	acabado	SK	
P030	933.811.616		picaporte suelto 60-70	laton pul.	✓	1
P030	933.811.620		picaporte suelto 60-70	chromo br.	✓	1
3534	933.811.985	8mm	cuadradillo	laton mate	✓	1
3534	933.811.114	8mm	cuadradillo	chromo mate	✓	1
3531	934.811.974	d:65	pomo tirador fijo	laton mate	✓	1
3531	933.811.103	d:65	pomo tirador fijo	chromo mate	✓	1
3520	933.811.963	50mm	portero automatico	laton mate	✓	1
3520	933.811.092	50mm	portero automatico	chromo mate	✓	1
	933.811.243	90x90	placa decorativa	laton mate	✓	1
	933.811.254	264x77	placa decorativa	laton mate	✓	1

Placas decorativas latón mate

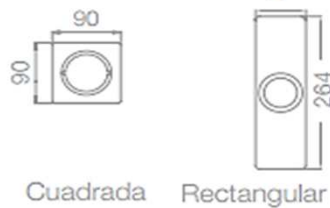
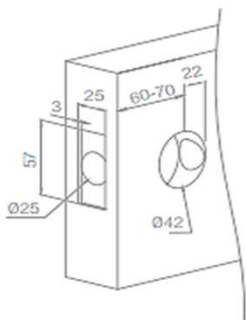

<p>Puertas de paso</p>	<p>Solo llave</p>
<p>Condena</p>	<p>Portero electrónico</p>
<p>Llave y condena</p>	<p>Cuadradillo: Pomo tirador</p>





14.10

**pomo 3900**

TESA

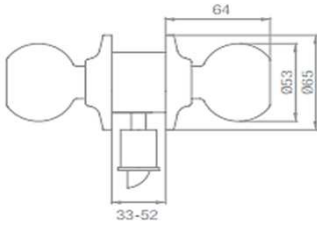

item	referencia	medidas	tipo	acabado	SK	
3505	933.811.902	d:65	puerta de paso	laton pul.	✓	1
3503	933.811.913	d:65	baño/condena	laton pul.	✓	1
3500	933.811.924	d:65	entrada	laton pul.	✓	1
3501	933.811.535	d:65	solo llave/condenar	laton pul.	p	1
3502	933.811.546	d:65	porteria/sin cond.	laton pul.	p	1
3505	933.811.935	d:65	puerta de paso	chromo br.	✓	1
3503	933.811.946	d:65	baño/condena	chromo br.	✓	1
3500	933.811.950	d:65	entrada	chromo br.	✓	1
3501	933.811.550	d:65	solo llave/condenar	chromo br.	p	1
3502	933.811.594	d:65	porteria/sin cond.	chromo br.	p	1
3505	933.811.961	d:65	puerta de paso	chromo mate	✓	1
3503	933.811.972	d:65	baño/condena	chromo mate	✓	1
3500	933.811.983	d:65	entrada	chromo mate	✓	1
3501	933.811.561	d:65	solo llave/condenar	chromo mate	p	1
3502	933.811.583	d:65	porteria/sin cond.	chromo mate	p	1
3505	933.811.994	d:65	puerta de paso	negro mate	✓	1
3503	933.811.005	d:65	baño/condena	negro mate	✓	1
3500	933.811.016	d:65	entrada	negro mate	✓	1
3501	933.811.572	d:65	solo llave/condenar	negro mate	p	1
3502	933.811.605	d:65	porteria/sin cond.	negro mate	p	1

Sistema Cuadradillo



item	referencia	medidas	tipo	acabado	SK	
PO30	933.811.616		picaporte suelto 60-70	laton pul.	✓	1
PO30	933.811.620		picaporte suelto 60-70	chromo br.	✓	1
3534	933.811.836	8mm 8mm	cuadradillo	laton pul.	✓	1
3534	933.811.101	8mm 8mm	cuadradillo	chromo br.	✓	1
3534	933.811.974	8mm 8mm	cuadradillo	chromo mate	✓	1
3534	933.811.381	8mm 8mm	cuadradillo	negro mate	✓	1
3931	933.811.825	d:65 d:65	pomo tirador fijo	laton pul.	✓	1
3931	933.811.933	d:65 d:65	pomo tirador fijo	chromo mate	✓	1

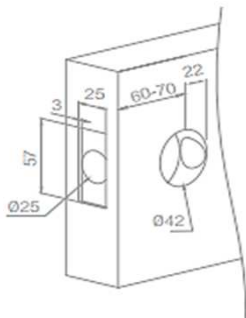

Placas decorativas latón mate

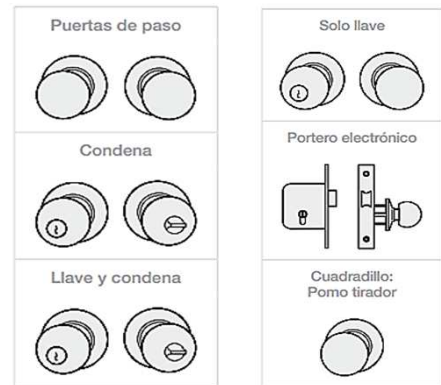
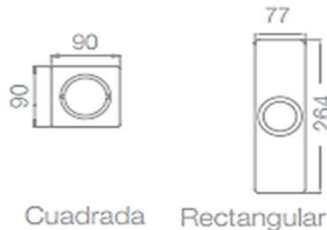



14.10 pomo acces mira



item	referencia	medidas	tipo	acabado	SK	
3M05R60-70	933.811.053	d:50	puerta de paso	ef.inox	✓	1
3M03R60-70	933.811.064	d:50	baño/dormitorio	ef.inox	✓	1
3M00R60-70	933.811.075	d:50	puerta exterior	ef.inox	✓	1



manilla tesa 3B



item	referencia	medidas	tipo	acabado	SK	
3B05	127.811.443	d:65	puerta de paso	laton pul.	✓	1
3B03	126.811.465	d:65	baño/condena	laton pul.	✓	1
3B00	126.811.480	d:65	entrada	laton pul.	✓	1
3B05	127.811.432	d:65	puerta de paso	chromo mate	✓	1
3B03	126.811.454	d:65	baño/condena	chromo mate	✓	1
3B00	126.811.476	d:65	entrada	chromo mate	✓	1
PO30	126.811.616		picaporte suelto 60-70	laton pul.	✓	1
PO30	126.811.620		picaporte suelto 60-70	chromo br.	✓	1
3B34	126.811.174	8mm	cuadradillo DERECHO	laton pul.	✓	1
3B34	126.811.303	8mm	cuadradillo IZQUIERDO	laton pul.	✓	1
3B34	126.811.962	8mm	cuadradillo DERECHO	chromo mate	✓	1
3B34	126.811.973	8mm	cuadradillo IZQUIERDO	chromo mate	✓	1

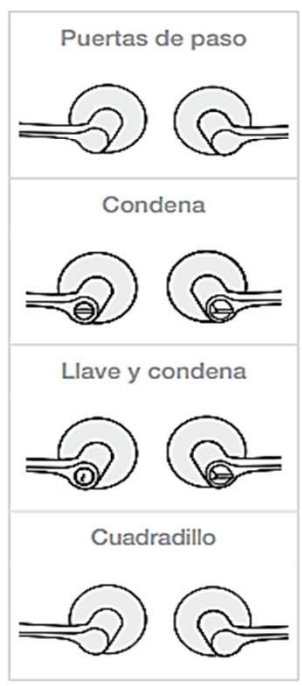
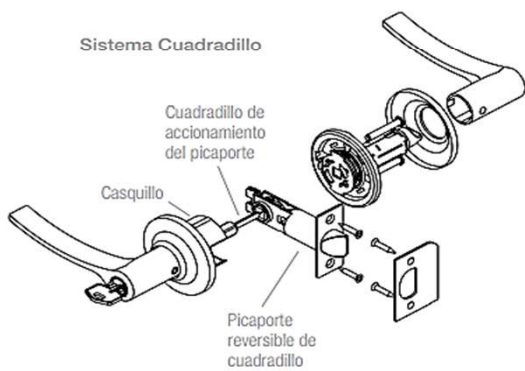
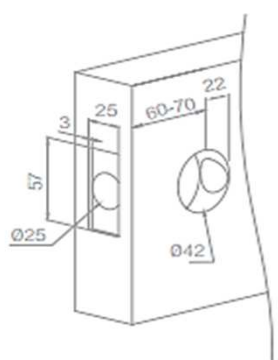
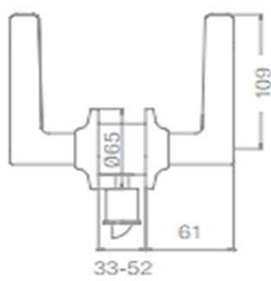



14.10

TESA

**pomo acces coma**



item	referencia	medidas	entrada	acabado	SK	
3C05R60-70	933.811.086	d:50	60-70	ef.inox	✓	1
3C03R60-70	933.811.090	d:50	60-70	ef.inox	✓	1
3C00R60-70	933.811.101	d:50	60-70	ef.inox	✓	1



Puerta de paso



Baño/dormitorio



Puerta exterior

**juego dos pomos fijos o giratorios i-1260**



referencia	medidas	tipo	largo	acabado	SK	
933.131.063	d:50	fijo	44	inox mate	✓	1
933.131.074	d:50	giratorio	48	inox mate	✓	1

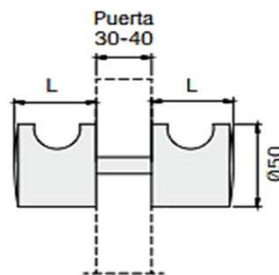

Incluye kit de fijacion

**pomo giratorio con placa**



referencia	medidas	material	acabado	SK	
933.131.740	240x46	laton	laton pul.	✓	1
933.131.151	240x46	laton	ef.inox	✓	1





**14.10** pomo giratorio DUTY



referencia	medidas		acabado	SK	
933.811.162	d:50	laton	ef.inox	✓	1
933.131.173	d:50	laton	laton pul.	✓	1

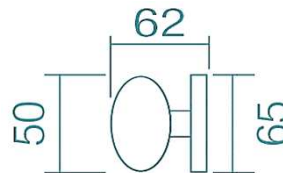

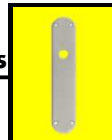

14.11

**placa para para montar manillas**

Sistema de muelle metálico independiente.

**Importante:**

Placa adecuada para montar todas las rosetas que no disponen de la misma referencia con placa larga. No precisa de unión entre placa y manilla, gracias al sistema de muelle que incorpora.

**Importante**

Modelo adecuado para montar con todas las rosetas que no disponen de la misma referencia con placa larga (montaje a cuenta del cliente).

referencia	medidas	acabado	SK	
933.131.514	246x47	cromo mate	✓	1
933.131.536	246x47	cromo br.	✓	1
933.131.540	246x47	ef.inox	✓	1
933.131.392	8x65	zincado	✓	1



cuadradillo



Especialmente indicado para el montaje en puertas de entrada con manetas de roseta. El cuadradillo se expande apretando la tuerca, y vuelve a su posición original aflojándola.

**placa para para montar manillas acero inox**

referencia	medidas	material	acabado	SK	
933.131.157	245x45	a.inox	inox mate	✓	1



Importante Modelo adecuado para montar con todas las rosetas que no disponen de la misma referencia



# 14.11 letras y numeros min acero inox



referencia	medidas	simbolo	material	acabado	SK	
126.811.216	60x60	a	a.inox	i.mate	p	1
126.811.231	60x60	b	a.inox	i.mate	p	1
126.811.253	60x60	c	a.inox	i.mate	p	1
126.811.275	60x60	d	a.inox	i.mate	p	1
126.811.290	60x60	/	a.inox	i.mate	p	1
126.811.010	60x60	0	a.inox	i.mate	p	1
126.811.032	60x60	1	a.inox	i.mate	p	1
126.811.054	60x60	2	a.inox	i.mate	p	1
126.811.076	60x60	3	a.inox	i.mate	p	1
126.811.091	60x60	4	a.inox	i.mate	p	1
126.811.113	60x60	5	a.inox	i.mate	p	1
126.811.135	60x60	6	a.inox	i.mate	p	1
126.811.150	60x60	7	a.inox	i.mate	p	1
126.811.172	60x60	8	a.inox	i.mate	p	1
125.811.194	60x60	9	a.inox	i.mate	p	1
125.811.220	150x150	a	a.inox	i.mate	p	1
125.811.242	150x150	b	a.inox	i.mate	p	1
125.811.264	150x150	c	a.inox	i.mate	p	1
125.811.286	150x150	d	a.inox	i.mate	p	1
125.811.301	150x150	/	a.inox	i.mate	p	1
125.811.021	150x150	0	a.inox	i.mate	p	1
125.811.043	150x150	1	a.inox	i.mate	p	1
125.811.065	150x150	2	a.inox	i.mate	p	1
125.811.080	150x150	3	a.inox	i.mate	p	1
125.811.102	150x150	4	a.inox	i.mate	p	1
125.811.124	150x150	5	a.inox	i.mate	p	1
125.811.146	150x150	6	a.inox	i.mate	p	1
125.811.161	150x150	7	a.inox	i.mate	p	1
125.811.183	150x150	8	a.inox	i.mate	p	1
125.811.205	150x150	9	a.inox	i.mate	p	1

## juego ojo buey sin cristal



referencia	medidas	material	acabado	SK	
120.131.535	d:380	acero aisi304	a.inox	i.mate	✓ 1

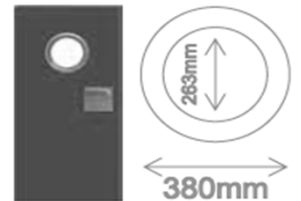

no incluye crista.



manillera , accesorios



b

p= bajo pedido

✓ = stock



**pictografía min acero inox**

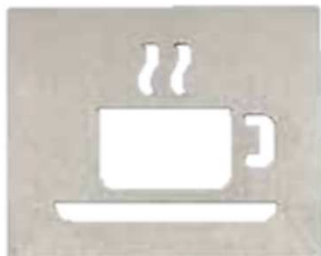

referencia	medidas	simbolo	material	acabado	SK	
125.811.216	100x100	hombre/mujer	a.inox	i.mate	p	1
125.811.231	100x100	hombre	a.inox	i.mate	p	1
125.811.253	100x100	mujer	a.inox	i.mate	p	1
125.811.275	100x100	discapitado	a.inox	i.mate	p	1
125.811.290	100x100	recepcion/oficina	a.inox	i.mate	p	1
125.811.010	100x100	reunion	a.inox	i.mate	p	1
125.811.032	100x100	flecha diagonal	a.inox	i.mate	p	1
125.811.054	100x100	flecha horizontal	a.inox	i.mate	p	1
125.811.076	100x100	ascensor	a.inox	i.mate	p	1
125.811.091	100x100	stop	a.inox	i.mate	p	1
125.811.113	100x100	cafeteria	a.inox	i.mate	p	1
125.811.135	100x100	telefono	a.inox	i.mate	p	1
125.811.150	100x100	no fumar	a.inox	i.mate	p	1
125.811.172	100x100	fumar	a.inox	i.mate	p	1
933.131.452		soporte	a.inox	i.mate	p	1



El soporte lateral permite la sujeción perpendicular respecto a la pared.

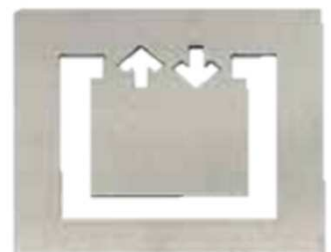

**pictografía classic acero inox**



referencia	medidas	simbolo	material	acabado	SK	
933.131.803	d:75	hombre	a.inox	i.mate	✓	1
933.131.804	d:75	mujer	a.inox	i.mate	✓	1
933.131.805	d:75	toilette	a.inox	i.mate	✓	1

manilleria , accesorios





# 14.11 juego ojo buey con cristal



referencia	interior	exterior			acabado	SK	
120.862.250	d:200	d:250	acero aisi304	a.inox	i.mate		1
120.862.350	d:300	d:350	acero aisi304	a.inox	i.mate		1
120.862.450	d:400	d:450	acero aisi304	a.inox	i.mate		1

Incluye: cristal templado de 4mm  
 Para sección puerta de 40mm





14.12

**muletilla+desbloqueo zamak para placa**

referencia	medida	material	acabado	SK	
120.811.772	6 mm	zamak	laton pul.	✓	1
120.811.784	6 mm	zamak	chromo br.	✓	1
120.811.496	6 mm	zamak	chromo mate	✓	1
120.811.182	6 mm	zamak	ef.inox	✓	1

**muletilla+desbloqueo acero inox para placa**

referencia	medida	material	acabado	SK	
120.811.941	6 mm	a.inox	inox mate	✓	1

**muletilla+desbloqueo zamak para placa**



referencia	medida	material	acabado	SK	
120.811.691	6 mm	zamak	cuero pat.	✓	1
120.811.702	6 mm	zamak	br.env	✓	1
120.811.713	6 mm	zamak	pl.env	✓	1
120.131.988	6 mm	zamak	negro	✓	1

**muletilla con grupilla**

referencia	medida	material	acabado	SK	
120.131.142	6 mm	zamak	laton pul.	✓	25
120.131.439	6 mm	zamak	ef.inox	✓	25

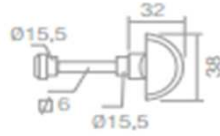

### 14.12 muletilla forja r-42



referencia		acabado	SK	
120.811.710	forja	negro	✓	1
120.811.721	forja	antiquario	✓	1
120.811.732	forja	pl.cnv	✓	1

### convertidor de cerradura a muletilla



referencia	material	acabado	SK	
933.811.024	acero	bicrom	✓	1

Adaptador para cerraduras de golpe y llave. Se acopla a cualquier cerradura de bombillo, convirtiéndola en muletilla

### grupilla presion



referencia	medidas	material	acabado	SK	
120.811.142	d:17	a.inox	i.mate	✓	100

### muletilla tornillo visto



referencia	medidas	material	acabado	SK	
120.811.224	d:41	laton	laton pul.	✓	1

### muletilla+desbloqueo con llave close

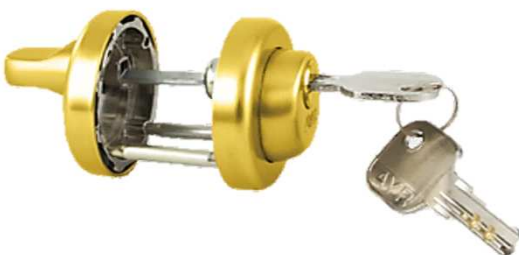

referencia		acabado	SK	ayr	
120.811.590		oro	✓		1
120.811.612		inox mate	✓		1





**muletilla+desbloqueo d:50**



referencia	medidas	material	acabado	SK	
121.811.782	d:50	laton	cromo mate	✓	1
120.811.771	d:50	laton	cromo br.	✓	1

**muletilla+desbloqueo d:50/52**



referencia	medidas	material	acabado	SK	
120.811.751	d:50	laton	laton pul.	✓	1
121.811.832	d:50	laton	lat.sat.	✓	1
121.811.005	d:52	zamak	ef.inox	✓	1
120.811.665	d:52	zamak	cuero pat.	✓	1
120.811.676	d:52	zamak	br.env	✓	1
120.811.680	d:52	zamak	pl.env	✓	1
120.811.194	d:52	zamak	lat.sat.	✓	1

**muletilla+desbloqueo d:50 less 4 mm grueso**



referencia	medidas	material	acabado	SK	
120.811.996	d:50	laton	cromo mate	✓	1
120.811.000	d:50	laton	cromo br.	✓	1

**muletilla+desbloqueo d:50 acero inox**



referencia	medidas	modelo	material	acabado	SK	
120.811.241	d:50	normal	a.inox	inox mate	✓	1
120.811.930	d:50	indicador	a.inox	inox mate	✓	1
120.811.863	d:50	discapitados	a.inox	inox mate	✓	1



indicador verde libre-rojo ocupado



discapitados





muletilla

### 14.12 muletilla+desbloqueo d:35



referencia	medidas	material	acabado	SK	
120.811.502	d:35	laton	laton pul.	✓	1
121.811.053	d:35	laton	lat.sat.	✓	1
120.811.524	d:35	laton	cromo br.	✓	1

### muletilla+desbloqueo totem d:35



referencia	medidas	material	acabado	SK	
120.811.876	d:35	a.inox	i.mate	✓	1
120.811.782	d:35	zamak	ef.inox	✓	1
120.811.632	d:35	zamak	cuero pat.	✓	1
120.811.643	d:35	zamak	br.env	✓	1
120.811.652	d:35	zamak	pl.env	✓	1
120.811.205	d:35	zamak	lat.sat.	✓	1
120.131.965	d:35	zamak	cuero	✓	1

### muletilla+desbloqueo d:35



referencia	medidas	material	acabado	SK	
120.131.968	d:35	zamak	laton pul.	✓	1
120.131.189	d:35	zamak	br.env	✓	1
120.131.633	d:35	zamak	cuero	✓	1
120.131.619	d:35	zamak	ef.inox	✓	1

### muletilla+desbloqueo 35x35 luke



referencia	medidas	material	acabado	SK	
121.811.793	35x35	zamak	ef.inox	✓	1





14.12

**muletilla+desbloqueo 35x35 nora**

referencia	medidas	material	acabado	SK	
120.811.962	35x35	laton	ef.inox	✓	1
120.811.973	35x35	laton	cromo mate	✓	1

**muletilla+desbloqueo 50x50 laton**

referencia	medidas	material	acabado	SK	
120.811.793	50x50	laton	cromo mate	✓	1
121.811.804	50x50	laton	cromo br.	✓	1
120.811.370	50x50	laton	laton pul.	✓	1
120.811.381	50x50	laton	blanco	✓	1
120.811.392	50x50	laton	negro	✓	1

**muletilla+desbloqueo 50x50 acero inox**

referencia	medidas	material	acabado	SK	
120.811.923	50x50	a.inox	inox mate	✓	1

**muletilla+desbloqueo 50x50**

referencia	medidas	material	acabado	SK	
120.811.804	50x50	zamak	ef.inox	✓	1



muletilla

**14.12** muletilla+desbloqueo 50x50 less 4 mm grueso



referencia	medidas	material	acabado	SK	
120.811.355	50x50	laton	cromo mate	✓	1
120.811.366	50x50	laton	cromo br.	✓	1

**muletilla+desbloqueo 52x52 ardea**



referencia	medidas	material	acabado	SK	
120.811.145	63x52	laton	cuero pat.	✓	1

**muletilla+desbloqueo 61x53 cassia**



referencia	medidas	material	acabado	SK	
120.811.092	61x53	laton	cuero pat.	✓	1
120.811.081	61x53	laton	laton pul.	✓	1

**muletilla+desbloqueo 63x52 latina**



referencia	medidas	material	acabado	SK	
120.811.352	63x52	laton	cuero pat.	✓	1







14.12

**muletilla+desbloqueo d:50 acero inox corredera**

referencia	medidas		material	acabado	SK	
205.811.196	d:50	normal	a.inox	inox mate	✓	1

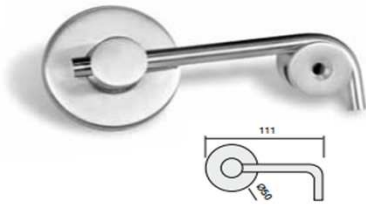
**cuadradillo varilla 8x1000mm**

referencia	medidas		material	acabado	SK	
121.131.894	8x1000		acero	zincado	✓	5

**cuadradillo**

referencia	medidas		material	acabado	SK	
121.811.206	65	7x6	acero	zincado	✓	1
121.811.195	65	7x7	acero	zincado	✓	1
121.811.735	100	8x8	acero	zincado	✓	1
121.811.496	150	8x8	acero	zincado	✓	1

**cuadradillo ranurado**

referencia	medidas		material	acabado	SK	
121.131.103	8x80		acero	zincado	✓	25
121.131.104	8x90		acero	zincado	✓	25
121.131.105	8x105		acero	zincado	✓	25

**cuadradillo expansion**

referencia	medidas		material	acabado	SK	
121.811.392	65	8x8+8x8	acero	zincado	✓	1

**placa cuadradillo fijo**

referencia	medidas	tipo	material	acabado	SK	
121.811.550	8x8	cuadradillo	acero	zincado	✓	1





**14.12** cuadradillo doble



referencia	medidas		materia	acabado	SK	
121.811.050	113mm	8x9+9x8	acero	zincado	✓	5
121.811.061	125mm	8x8+8x8	acero	zincado	✓	5

**escudo para cubrir hueco de pomo**



referencia	medidas		acabado	SK	
121.131.401	d:60		laton pul.	✓	2
121.131.418	d:60		ef.inox	✓	2



ejemplo

adapta el hueco de un antiguo pomo por una manilla roseta actual

**escudo para cubrir hueco de pomo**



referencia	medidas		acabado	SK	
121.131.402	60x60		laton pul.	✓	2
121.131.403	60x60		ef.inox	✓	2

**reductor cuadradillo nylon**



referencia	medidas	tipo	materia	acabado	SK	
121.131.405	7-6	cuadradillo	nylon	negro	✓	25
121.131.406	8-7	esparrago	nylon	negro	✓	25
121.131.407	9-8	cuadradillo	nylon	negro	✓	25

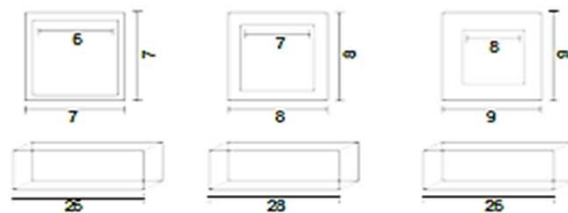

**reductor ACERO**



referencia	medidas		materia	acabado	SK	
121.811.691	8-6		acero	zincado	✓	1
121.811.022	8-7		acero	zincado	✓	1
121.811.046	9-8		acero	zincado	✓	1





**bocallave albin serreta y borjas d:50**



referencia	medidas	modelo	material	acabado	SK	
#####	d:50	serreta	laton	laton pul.	✓	1
#####	d:50	serreta	laton	romo br.	✓	1
#####	d:50	serreta	laton	romo mate	✓	1
#####	d:50	serreta	laton	ef.inox	✓	1
#####	d:50	serreta	laton	laton mate	✓	1
#####	d:50	borjas	laton	laton pul.	✓	1
#####	d:50	borjas	laton	romo br.	✓	1
#####	d:50	borjas	laton	romo mate	✓	1
#####	d:50	borjas	laton	ef.inox	✓	1
#####	d:50	borjas	laton	laton mate	✓	1

① Serreta    ② Borjas

**bocallave albin serreta y borjas d:52**



① Serreta    ② Borjas

referencia	medidas	modelo	material	acabado	SK	
120.811.490	d:50	serreta	zamak	ef.inox	✓	1
120.811.501	d:50	serreta	zamak	laton mate	✓	1
120.811.573	d:50	serreta	zamak	cuero pat.	✓	1
120.811.584	d:50	serreta	zamak	br.env	✓	1
120.811.595	d:50	serreta	zamak	pl.env	✓	1
120.811.220	d:50	serreta	zamak	laton pul.	✓	1
120.131.915	d:50	serreta	zamak	cuero	✓	1
120.811.606	d:50	borjas	zamak	cuero pat.	✓	1
120.811.610	d:50	borjas	zamak	br.env	✓	1
120.811.621	d:50	borjas	zamak	pl.env	✓	1
120.811.216	d:50	borjas	zamak	laton pul.	✓	1





### 14.13 bocallave less serreta y borjas d:50 grueso 4 mm



referencia	medidas		material	acabado	SK	
121.811.033	d:50	serreta	laton	chromo br.	✓	1
120.811.011	d:50	serreta	laton	chromo mate	✓	1
120.811.044	d:50	borjas	laton	chromo br.	✓	1
120.811.022	d:50	borjas	laton	chromo mate	✓	1

### bocallave seguridad selena serreta y borjas d:53 acero inox



referencia	medidas		material	acabado	SK	
120.811.896	d:53	serreta	a.inox	i.mate	✓	1
120.811.900	d:53	borjas	a,inox	i.mate	✓	1

El bocallave 120.811.896 está preparado para la fijación de los tornillos que se precisan para la instalación del bocallave de seguridad de la cerradura.

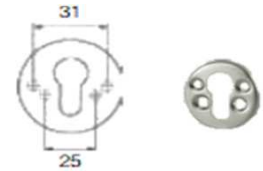

### bocallave seguridad selena serreta d:52 acero



referencia	medidas		material	acabado	SK	
120.811.853	d:52		acero	laton pul.	✓	1
120.811.864	d:52		acero	chromo mate	✓	1

Especialmente concebido para la colocación en puertas blindadas. Incluye elemento preparado para la fijación de los tornillos que se precisan para la instalación del bocallave de seguridad de la cerradura.

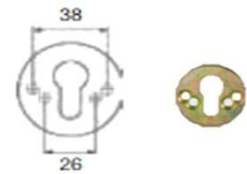

### bocallave seguridad toy serreta d:58 visto



referencia	medidas		material	acabado	SK	
121.811.473	d:58		acero	laton mate	✓	1
120.811.310	d:58		a.inox	i.mate	✓	1

Especialmente concebido para la colocación en puertas blindadas. Incluye elemento preparado para la fijación de los tornillos que se precisan para la instalación del bocallave de seguridad de la cerradura.





14.13

**bocallave cuadrado laton serreta y borjas 50x50**



① Serreta ② Borjas

referencia	medidas	modelo	material	acabado	SK	
120.811.053	50x50	serreta	laton	chromo mate	✓	1
120.811.042	50x50	serreta	laton	chromo br.	✓	1
120.811.506	50x50	serreta	laton	laton pul.	✓	1
120.811.521	50x50	serreta	laton	blanco mt	✓	1
120.811.543	50x50	serreta	laton	negro mate	✓	1
120.811.031	50x50	borjas	laton	chromo mate	✓	1
120.811.020	50x50	borjas	laton	chromo br.	✓	1
120.811.510	50x50	borjas	laton	laton pul.	✓	1
120.811.532	50x50	borjas	laton	blanco mt	✓	1
120.811.554	50x50	borjas	laton	negro mate	✓	1

**bocallave forjado**

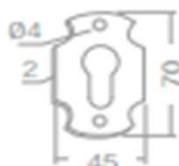

referencia	material	acabado	SK	
120.811.034	forja	negro	✓	1
120.811.045	forja	antiquario	p	1
121.811.056	forja	pl.env	p	1

**bocallave less cuadrado serreta y borjas 50x50 grueso 4 mm**



① Serreta ② Borjas

referencia	medidas	modelo	material	acabado	SK	
120.811.462	50x50	serreta	laton	chromo mate	✓	1
120.811.484	50x50	serreta	laton	chromo br.	✓	1
120.811.473	50x50	borjas	laton	chromo mate	✓	1
120.811.495	50x50	borjas	laton	chromo br.	✓	1

**bocallave selena cuadrado serreta y borjas 52x52 acero inox**



① Serreta ② Borjas

referencia	medida	material	acabado	SK	
120.811.901	52x52	a.inox	i.mate	p	1
120.811.912	52x52	a.inox	i.mate	p	1





### 14.13 bocallave ciego redondo d:53

referencia	medida	material	acabado	SK	
120.811.895	d:53	a.inox	i.mate	✓	1



### bocallave latina

referencia	medidas	modelo	material	acabado	SK	
120.811.396	63x52	serreta	laton	cuero pat.	✓	1
120.811.374	63x52	borjas	laton	cuero pat.	✓	1



① Serreta

② Borjas

### bocallave cassia

referencia	medidas	modelo	material	acabado	SK	
120.811.125	61x53	serreta	laton	cuero pat.	✓	1
120.811.103	61x53	borjas	laton	laton pul.	✓	1
120.811.136	61x53	serreta	laton	cuero pat.	✓	1
120.811.114	61x53	borjas	laton	laton pul.	✓	1



① Serreta

② Borjas

### bocallave ardea

referencia	medidas	modelo	material	acabado	SK	
120.811.123	63x52	serreta	laton	cuero pat.	✓	1
120.811.134	63x52	borjas	laton	cuero pat.	✓	1



① Serreta

② Borjas



**bocallave seguridad cono d:54**

referencia	medida	material	acabado	SK	
120.131.931	d:54	acero	lat.sat.	✓	1
120.131.932	d:54	acero	inox mate	✓	1

**bocallave escudo seguridad**

referencia	medida	material	acabado	SK	
120.131.941	d:62x10	acero	lat.sat.	✓	1
120.131.942	d:62x10	acero	inox mate	✓	1

**bocallave placa laton**

referencia	medida	material	acabado	SK	
120.131.825	60x35	laton	laton pul.	✓	2
120.131.826	60x35	laton	lat.sat.	✓	2
120.131.827	60x35	laton	ef.inox	✓	2
120.131.828	60x60	laton	laton pul.	✓	2
120.131.829	60x60	laton	lat.sat.	✓	2
120.131.830	60x60	laton	ef.inox	✓	2
120.131.831	80x60	laton	laton pul.	✓	2
120.811.832	80x60	laton	lat.sat.	✓	2
120.131.833	80x60	laton	ef.inox	✓	2
120.131.810	80x80	laton	laton pul.	✓	2
120.131.811	80x80	laton	lat.sat.	✓	2
120.131.812	80x80	laton	ef.inox	✓	2
120.131.813	100x70	laton	laton pul.	✓	2
120.131.814	100x70	laton	lat.sat.	✓	2
120.131.815	100x70	laton	ef.inox	✓	2



### 14.13 placa laton ciega



referencia	medida	material	acabado	SK	
120.131.816	60x35	laton	laton pul.	✓	2
120.131.817	60x35	laton	lat.sat.	✓	2
120.131.818	60x35	laton	ef.inox	✓	2
120.131.819	60x60	laton	laton pul.	✓	2
120.131.820	60x60	laton	lat.sat.	✓	2
120.131.821	60x60	laton	ef.inox	✓	2
120.131.822	80x60	laton	laton pul.	✓	2
120.131.823	80x60	laton	lat.sat.	✓	2
120.131.824	80x60	laton	ef.inox	✓	2
120.131.801	80x80	laton	laton pul.	✓	2
120.131.802	80x80	laton	lat.sat.	✓	2
120.131.803	80x80	laton	ef.inox	✓	2
120.131.804	100x70	laton	laton pul.	✓	2
120.131.805	100x70	laton	lat.sat.	✓	2
120.131.806	100x70	laton	ef.inox	✓	2
120.131.807	250x90	laton	laton pul.	✓	2
120.131.808	250x90	laton	lat.sat.	✓	2
120.131.809	250x90	laton	ef.inox	✓	2

### placa ciega acero inox

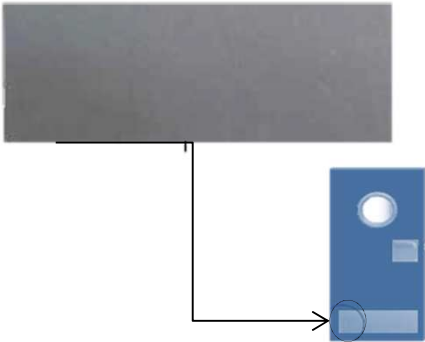

referencia	medidas	tipo acero	material	acabado	SK	
121.131.816	600x250	AISI 304	a.inox	inox mate	✓	1
121.131.817	700x250	AISI 304	a.inox	inox mate	✓	1
121.131.818	800x250	AISI 304	a.inox	inox mate	✓	1
121.131.819	900x250	AISI 304	a.inox	inox mate	✓	1
121.131.820	1000x250	AISI 304	a.inox	inox mate	✓	1
121.131.821	1200x250	AISI 304	a.inox	inox mate	✓	1

### placa pisa puerta



referencia	medidas	acabado	SK	
120.131.842	147x98	lat.sat.	✓	1





14.14

**tope puerta quick**



referencia	medida		material	acabado	SK	
123.811.030	30x30	cromo mate/negro	zamak	cromo mate	✓	1

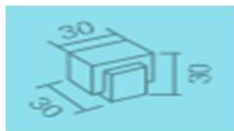

**tope puerta down**



referencia	medida		material	acabado	SK	
124.811.041	35x35	cromo mate/negro	zamak	cromo mate	✓	1

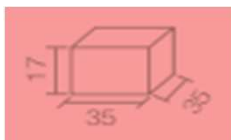

**tope puerta dado**



referencia	medida		material	acabado	SK	
123.811.574	20x25	bicolor con negro	laton	cromo mate	✓	1
123.811.563	20x25	bicolor con negro	laton	cromo br.	✓	1
123.811.552	20x25	bicolor con negro	laton	laton mate	p	1
123.811.541	20x25	bicolor con negro	laton	laton pul.	p	1

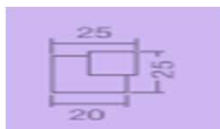

**tope puerta cubo**



referencia	medida		material	acabado	SK	
123.811.596	30x30	bicolor con negro	laton	cromo mate	✓	1
123.811.585	30x30	bicolor con negro	laton	cromo br.	✓	1
123.811.600	30x30	bicolor con negro	laton	negro	p	1
123.811.611	30x30	bicolor con negro	laton	blanco	p	1

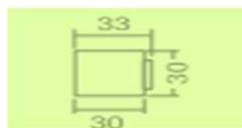

manilleria , accesorios



a

✓ = stock

p = bajo pedido



topes

### 14.14 tope puerta cuadra



referencia	medida	material	acabado	SK	
123.811.336	d:24	laton	ef.inox	✓	1



### tope puerta boston con base



referencia	medida	material	acabado	SK	
123.811.203	d:28	zamak	ef.inox	✓	100

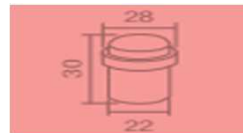

### tope puerta telmo



referencia	medida	material	acabado	SK	
123.811.395	d:26	a.inox	i.mate	✓	1



### tope puerta sanson



referencia	medida	material	acabado	SK	
123.811.375	d:30	a.inox	i.mate	✓	1

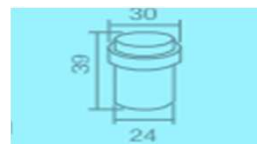



14.14

**freno retenedor a suelo**



referencia	medida	material	acabado	SK	
123.811.536	125x30	laton	bronce	✓	1

**freno retenedor deslizante libre**



referencia	medida	material	acabado	SK	
123.131.196	d:90x40	a.inox	i.mate	✓	1

No es necesario atornillar al suelo. Apto para todos los pavimentos.  
Evita los golpes al abrir y cerrar puertas.  
Base antideslizante.

**freno retenedor puerta de pie**



referencia	medida	material	acabado	SK	
123.131.157	130x25	laton	blanco	✓	1
123.131.158	130x25	laton	negro	✓	1
123.131.159	130x25	laton	oro	✓	1
123.313.160	130x25	laton	ef.inox	✓	1



**tope puerta retenedor adhesivo**

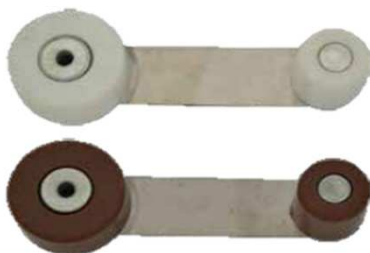

referencia	medida	material	acabado	SK	
123.131.494	100x25x34	acero	blanco	✓	1
123.131.495	100x25x34	acero	marron	✓	1





### 14.14 tope puerta classic adhesivo



referencia	medida	material	acabado	SK	
123.131.492	45x45	acero	blanco	✓	2
123.131.493	45x45	acero	marron	✓	2

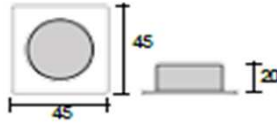

### tope puerta seta adhesivo



referencia	medida	material	acabado	SK	
123.131.884	d:36	madera	haya	✓	2
123.131.882	d:36	madera	blanco	✓	2
123.131.883	d:36	madera	sapely	✓	2
123.131.881	d:36	madera	roble	✓	2

### retenedor suelo



referencia	medida	material	acabado	SK	
123.131.144	d:26	laton	laton pul.	✓	1
123.131.145	d:26	laton	cromo br.	✓	1

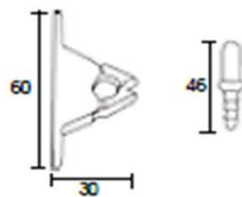

### retenedor pared



referencia	medida	material	acabado	SK	
123.131.146	d:26	laton	laton pul.	✓	1
123.131.147	d:26	laton	cromo br.	✓	1

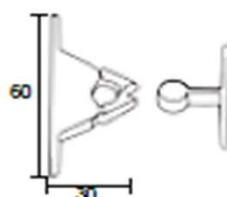



14.14

**retenedor clip 3**

referencia	medida	acabado	SK	
123.131.520	40X33X36	negro	✓	10

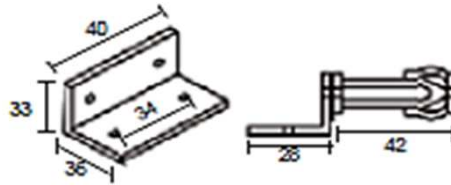

**tope puerta timoteu adhesivo**

referencia	medida	material	acabado	SK	
123.811.225	d:20	laton	laton pul.	✓	1
123.811.314	d:20	laton	cuero pat.	✓	1



**tope puerta edy adhesivo**

referencia	medida	material	acabado	SK	
123.811.482	48	madera	sapely	✓	1
123.811.493	48	madera	roble	✓	1



**tope puerta otto adhesivo con iman**

referencia	medida	material	acabado	SK	
123.811.471	48	madera	roble	✓	1





topes

14.14

**tope puerta franz adhesivo con espuma**



referencia	medida	material	acabado	SK	
123.811.316	D:47	ABS	cromo mate	✓	1

**tope puerta mike adhesivo transparente**



referencia	medida	material	acabado	SK	
123.811.772	d:50	resina	transp.	✓	1

Permite pasar inadvertido con cualquier tipo de suelo

**tope puerta lux**



referencia	medida	material	acabado	SK	
123.811.066	d:45	zamak	cromo mate	✓	1

**tope puerta allan adhesivo con iman**



referencia	medida	material	acabado	SK	
123.811.320	d:52	plastico	cromo mate	✓	1

**tope retenedor esau**



referencia	material	acabado	SK	
123.811.303	laton	laton pul.	✓	1
123.811.292	laton	cromo br.	✓	1

**tope puerta turin**



referencia	largo	material	acabado	SK	
123.811.041	80	a.inox	inox mate	✓	1

manillera , accesorios



f

p= bajo pedido

✓ = stock



14.15

**percha escolar**



referencia	material	acabado	SK	
120.811.604	acero	zincado	✓	1
120.131.008	acero	laton pul.	✓	25
120.131.010	acero	blanco	✓	25



**percha deco**



referencia	material	acabado	SK	
120.811.033	a.inox	i.mate	✓	1



**percha cuadro**



referencia	material	acabado	SK	
121.811.426	a.inox	i.mate	✓	1



**percha adriel**



referencia	material	acabado	SK	
120.811.230	a.inox	i.mate	✓	1





perchas

### 14.15 percha tudor



referencia	material	acabado	SK	
120.811.820	zamak	cromo mate	✓	1
120.811.831	zamak	cromo br.	✓	1

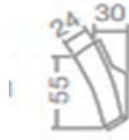

### percha city



referencia	material	acabado	SK	
120.811.805	zamak	cromo mate	✓	1
120.811.816	zamak	cromo br.	✓	1



### percha venus

ACERO INOXIDABLE AUSTENITICO\*



referencia	medida	material	acabado	SK	
120.811.734	71	aisi 304	a.inox	i.mate	✓
120.811.723	180	aisi 304	a.inox	i.mate	✓

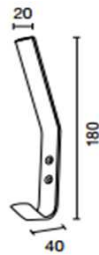

### percha jane



referencia	medida	modelo	material	acabado	SK	
120.811.413	20	simple	a.inox	i.mate	✓	1
120.811.424	126	doble	a.inox	i.mate	✓	1

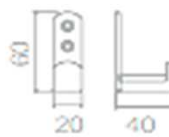





14.15

**percha probador**

referencia	medida	material	acabado	SK	
120.131.025	55x20	a.inox	i.mate	✓	4



**percha jaws**

referencia	material	acabado	SK	
120.811.435	zamak	ef.inox	✓	1



**percha claus**

referencia	material	acabado	SK	
120.811.551	zamak	ef.inox	✓	1
120.811.562	zamak	cuero pat.	✓	1
120.811.356	zamak	laton pul.	✓	1



**percha gancho**

referencia	material	acabado	SK	
120.811.426	laton	oro	✓	1
120.811.452	laton	negro mate	✓	1





perchas

**14.15** percha doble



referencia	medida	material	acabado	SK	
120.131.024	170x42	a.inox	i.mate	✓	4

**percha gancho inox**



referencia	medida	material	acabado	SK	
120.131.023	32x50	a.inox	i.mate	✓	4

**percha rustica**



referencia	material	acabado	SK	
120.131.001	acero	br.env	✓	4
120.131.003	acero	pl.env	✓	4
120.131.004	acero	laton pul.	✓	4

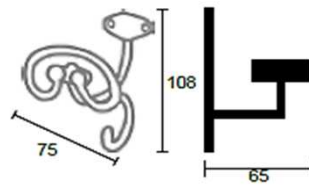

**percha scorpio**



referencia	material	acabado	SK	
120.131.011	acero	br.env	✓	4
120.131.013	acero	pl.env	✓	4
120.131.014	acero	laton pul.	✓	4

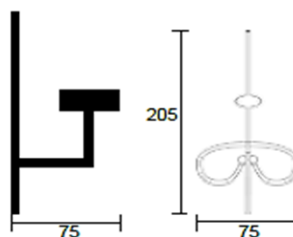

manilleria , accesorios



d

p= bajo pedido

✓ = stock



14.15

**percha rustica 5**



referencia	material	acabado	SK	
120.131.015	forja	negro	✓	4

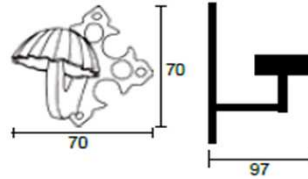

**percha rustica 6**



referencia	material	acabado	SK	
120.811.016	forja	negro	✓	4

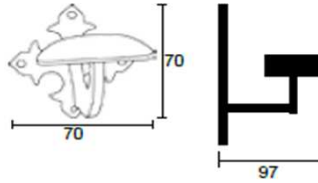

**percha rustica 7**



referencia	material	acabado	SK	
120.131.017	forja	negro	✓	4

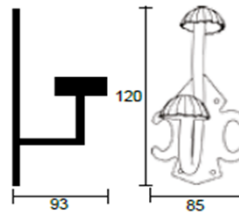

**percha rustica 8**



referencia	material	acabado	SK	
120.131.018	forja	negro	✓	4

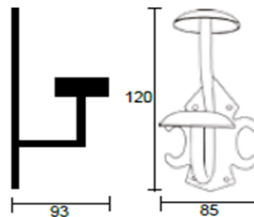

**colgador extintor**

ACERO



referencia	medida	modelo	material	acabado	SK	
120.131.506	75x75x35	2 KG	a.inox	cincado	✓	26
120.131.507	60x75x48	5 KG	a.inox	cincado	✓	25
120.131.502	60x70x11	6 KG	a.inox	cincado	✓	1/25

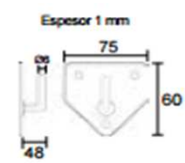
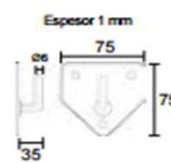
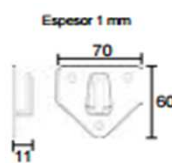



### 14.15 percha tope

ACERO INOXIDABLE AUSTENITICO\*



referencia	medida	modelo	material	acabado	SK	
120.811.056	71	simple	a.inox	i.mate		1

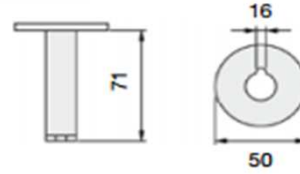

### percha NEWYORK



referencia	L	W	H	material	acabado	SK	
120.031.093	90	80	54	zamak	cromo br.		50

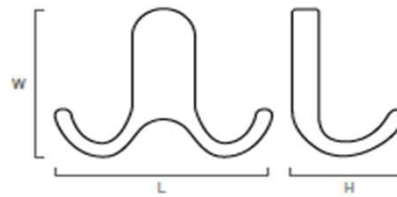

### percha ARPON



referencia	L	W	H	material	acabado	SK	
120.031.094	70	70	48	ABS	cromo br.		50

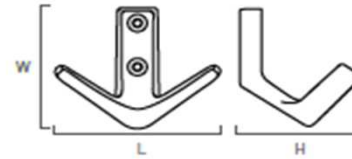

### percha NEW

ACERO



referencia	material	acabado	SK	
120.298.175	zamak	cromo br.		10
120.298.176	zamak	ef.inox		10
120.298.177	zamak	cromo mate		10

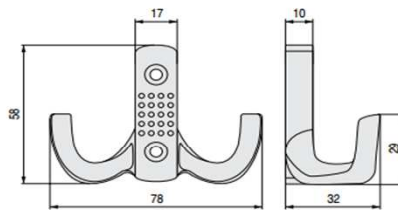

### percha POL

ACERO



referencia	L	W	H	material	acabado	SK	
120.031.803	68	57	19	zamak	cromo br.		50
120.031.893	68	57	19	zamak	blanco		50

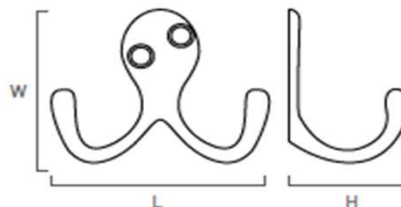



14.16

**pomo pta seta eco**



referencia	material	acabado	SK	
126.811.140	a.inox	i.mate	✓	1



**pomo pta sfera**



referencia	material	acabado	SK	
129.811.810	laton	laton pul.	✓	1
129.811.821	laton	chromo br.	✓	1
129.811.832	laton	chromo mate	✓	1



**pomo pta bola**



referencia	material	acabado	SK	
129.811.976	a.inox	i.mate	✓	1



**pomo pta octogonal**



referencia	material	acabado	SK	
129.131.011	laton	laton pul.	✓	1

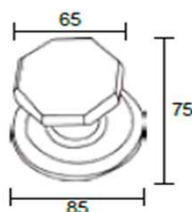



pomos entrada

### 14.16 pomo pta aros



referencia	material	acabado	SK	
129.131.008	laton	laton pul.	✓	1
120.131.002	laton	ef.inox	✓	1

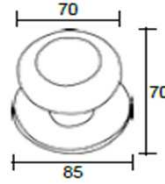

### pomo pta liso

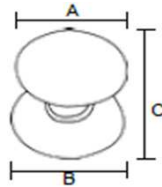

referencia	a x b x c	material	acabado	SK	
120.131.098	70x85x70	laton	laton pul.	✓	1
120.131.494	65x85x85	laton	br.env	✓	1
120.131.937	70x85x70	laton	cuero	✓	1
120.131.936	70x85x70	laton	chromo mate	✓	1
120.131.929	70x85x70	laton	negro	✓	1
120.131.920	70x85x70	laton	ef.inox	✓	1

### pomo pta baiko



referencia	medida	material	acabado	SK	
120.811.940	50x50	a.inox	i.mate	✓	1

### pomo pta deco



referencia	material	acabado	SK	
120.811.460	a.inox	chromo br.		1
120.811.471	a.inox	chromo mate		1
120.811.445	a.inox	laton pul.		1
120.811.456	a.inox	laton mate		1



manilleria , accesorios



b

p= bajo pedido

✓ = stock



14.16

**pomo pta qubik-2**



referencia	material	acabado	SK	
#####	laton	i.mate	✓	1
#####	laton	br.env	✓	1



**pomo pta wide**



referencia	material	acabado	SK	
#####	laton	laton pul.	p	1
#####	laton	romo br.	p	1
#####	laton	romo mate	p	1



**pomo pta fluo**



referencia	material	acabado	SK	
#####	laton	romo mate	✓	1
#####	laton	ef.inox	✓	1



**pomo pta cuadro**



referencia	material	acabado	SK	
129.811.515	laton	laton pul.	✓	1
129.811.526	laton	romo br.	p	1
129.811.530	laton	romo mate	p	1





**14.16** pomo pta 510



referencia	material	acabado	SK	
120.811.690	laton	cuero	✓	1



**pomo pta 520**



referencia	material	acabado	SK	
120.013.701	laton	cuero	✓	1



**pomo pta eco**



referencia	material	acabado	SK	
120.811.400	laton	laton pul.	✓	1
120.811.692	laton	cuero	✓	1



**pomo pta felipe II**



referencia	material	acabado	SK	
120.811.835	forja	negro	✓	1
120.811.846	forja	antiquario		1
120.811.850	forja	pl.env		1

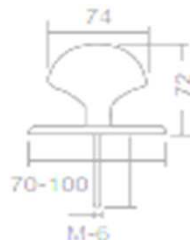





14.17

**llamador pta baculo**



referencia	material	acabado	SK	
129.811.772	laton	laton pul.	✓	1
129.811.783	laton	br.env	p	1
129.811.794	laton	ef.inox	p	1



**llamador pta elegant**



referencia	material	acabado	SK	
129.811.944	laton	chromo mate	✓	1



**llamador pta dintel**



referencia	material	acabado	SK	
129.811.006	laton	antiquario	p	1
127.811.010	laton	pl.env	p	1



**llamador pta quimera**



referencia	material	acabado	SK	
127.811.043	laton	antiquario	p	1
127.811.054	laton	pl.env	p	1



manilleria , accesorios



a

✓ = stock

p = bajo pedido



**14.17** llamador pta qubik



referencia	medidas	material	acabado	SK	
129.811.985	145x66	laton	ef.inox	✓	1

**llamador pta cisne**



referencia	material	acabado	SK	
129.131.802	laton	br.env	✓	1

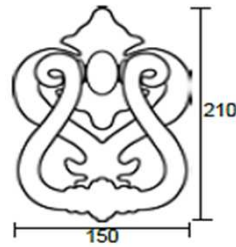

**llamador pta aro placa**



referencia	material	acabado	SK	
129.131.803	laton	br.env	✓	1

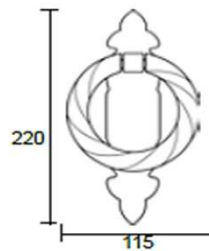

**llamador pta aro gallones**



referencia	material	acabado	SK	
129.131.804	laton	br.env	✓	1

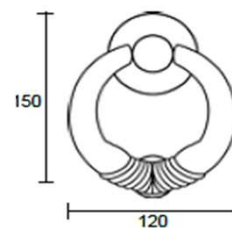



14.17

**llamador pta aro**



referencia	A	material	acabado	SK	
129.131.184	100	laton	br.env	✓	1
129.131.813	120	laton	br.env	✓	1
129.131.815	100	a.inox	cuero	✓	1
129.131.816	120	a.inox	cuero	✓	1
129.131.187	100	a.inox	laton pul.	✓	1

**llamador pta mano**

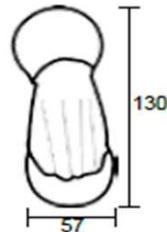

referencia	material	acabado	SK	
129.131.186	laton	br.env	✓	1
129.131.189	laton	laton pul.	✓	1

**llamador pta columna**

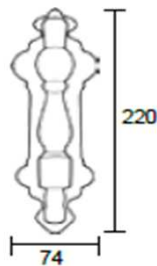

referencia	material	acabado	SK	
129.131.185	laton	br.env	✓	1
129.131.188	laton	laton pul.	✓	1

**llamador pta ingles**

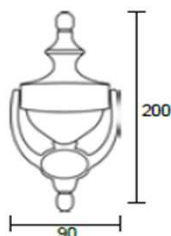

referencia	material	acabado	SK	
129.131.180	laton	laton pul.	✓	1
129.131.835	laton	cuero	✓	1
129.131.828	laton	ef.inox	✓	1
129.131.810	laton	negro	✓	1





**14.17** llamador pta leon



referencia	material	acabado	SK	
129.131.801	laton	br.env	✓	1

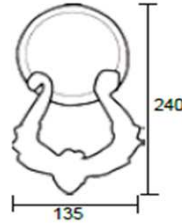

**campana rustica**



referencia	A x B	material	acabado	SK	
129.131.824	240x190	laton	br.env	✓	1

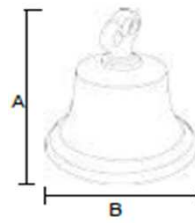

**soporte campana**



referencia	A x B	material	acabado	SK	
129.131.825	320x180	acero	negro	✓	1



**campana lisa**



referencia	A x B	material	acabado	SK	
129.131.822	140x120	a.inox	laton pul.		1
129.131.823	170x160	a.inox	laton pul.		1

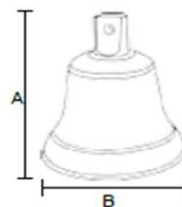



14.17

**llamador pta felipe II**



referencia	material	acabado	SK	
#####	hierro	negro	✓	1
#####	hierro	antico	p	1
#####	hierro	pl.env	p	1

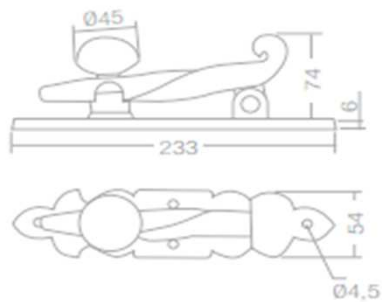

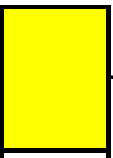

14.17

manilleria , accesorios



f

p= bajo pedido

✓ = stock



14.18

**clavo redondo liso decorativo**

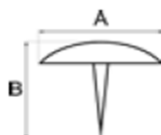

referencia	A	B	material	acabado	SK	
129.811.533	20	30	hierro	negro	✓	25
129.131.725	25	30	hierro	negro	p	25
129.131.701	30	30	hierro	negro	p	25
129.131.726	35	30	hierro	negro	p	25
129.131.702	40	30	hierro	negro	p	25

**clavo redondo golpeado decorativo**

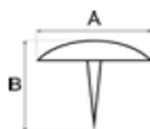

referencia	A	B	material	acabado	SK	
129.131.727	25	30	hierro	negro	p	25
129.131.728	30	30	hierro	negro	p	25
129.131.736	35	30	hierro	negro	p	25
129.131.736	40	30	hierro	negro	p	25

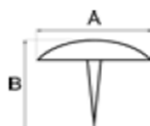
**clavo piramide golpeado decorativo**

referencia	A	B	material	acabado	SK	
129.131.729	25	30	hierro	negro	p	25
129.131.703	30	30	hierro	negro	p	25
129.131.730	35	30	hierro	negro	p	25

**clavo 8 picos decorativo**

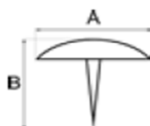
referencia	A	B	material	acabado	SK	
129.131.731	30	30	hierro	negro	p	25
129.131.732	40	30	hierro	negro	p	25





### 14.18 clavo 4 picos decorativo



referencia	A	B	material	acabado	SK	
129.131.733	20	20	hierro	negro		25
129.131.734	40	30	hierro	negro		25

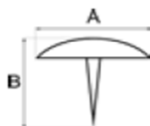

### clavo cuadrado forjado



referencia	material	acabado	SK		
129.811.592	25x25	hierro	negro		25
129.811.603	30x30	hierro	negro		25
129.811.614	25x25	hierro	anticuario		25
129.811.625	30x30	hierro	anticuario		25
129.811.636	25x25	hierro	pl.env		25
129.811.640	30x30	hierro	pl.env		25

### clavo 80 x 80 trebol forja artesanal

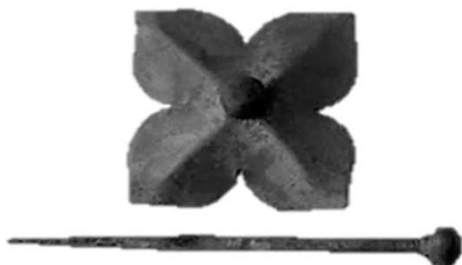

referencia	acabado	SK	
128.811.671	forja		1

### clavo forjado artesanal



referencia	medida	acabado	SK	
128.811.682	23x23	forja		1
128.811.693	30x30	forja		1









14.18

**clavo arabe laton decorativo**



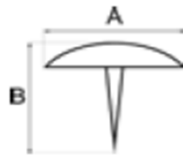

referencia	A	B	material	acabado	SK	
129.131.075	35	30	laton	laton env		25
129.131.175	35	30	laton	laton pul.		25



**clavo margarita laton decorativo**



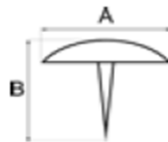

referencia	A	B	material	acabado	SK	
129.131.074	50	30	laton	laton env		25
129.131.174	50	30	laton	laton pul.		25



**clavo flor laton decorativo**



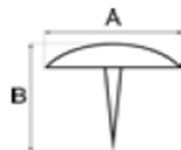

referencia	A	B	material	acabado	SK	
129.131.077	55	40	laton	laton env		25



**clavo piramide laton decorativo**



referencia	A	B	material	acabado	SK	
129.131.076	35	40	laton	laton env		25
129.131.176	35	40	laton	laton pul.		25

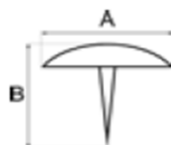



**14.18** clavo mozarabe decorativo



referencia	A	acabado	SK	
129.811.872	36	bronce env	✓	1
129.867.336	36	plata envej.	p	25

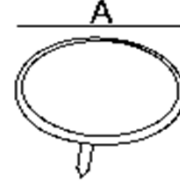

**clavo rombo decorativo**



referencia	A	B	acabado	SK	
129.867.340	50	66	bronce env	✓	25
129.867.341	50	66	plata envej.	✓	25

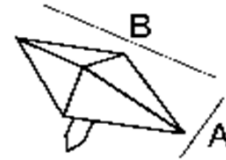

**clavo granada decorativo**



referencia	A	B	acabado	SK	
129.867.345	38	38	bronce env	p	1



**clavo MOZA decorativo**



referencia	acabado	SK	
129.811.883	laton cuero l. pat.	✓	1
129.811.894	laton laton pul.	✓	1

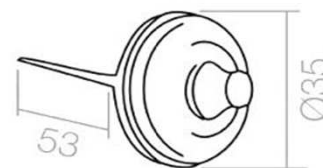



14.19

**mirilla ECONOMICA**

referencia	diametro	medida	material	acabado	SK	
573.811.296	14	35 a 60 mm	laton	laton mate	✓	1
573.811.784	14	35 a 60 mm	laton	bronce ingles	✓	1
573.811.300	14	35 a 60 mm	laton	chromo brillo	✓	1
573.811.016	14	35 a 60 mm	laton	chromo mate	✓	1
573.811.630	14	35 a 60 mm	laton	niquel mate	✓	1
573.811.130	16	<b>50 a 75 mm</b>	laton	laton mate	✓	1
573.131.459	14	35 a 60 mm	laton	negro	✓	1
573.131.105	14	35 a 60 mm	laton	cuero	✓	1

**mirilla GAMA ALTA**

referencia	diametro	medida	material	acabado	SK	
573.811.223	14	35 a 55 mm	laton	laton mate	✓	1
573.811.550	14	35 a 55 mm	laton	chromo brillo	✓	1
573.811.234	14	50 a 70 mm	laton	laton mate	✓	1
573.811.804	14	50 a 70 mm	laton	chromo brillo	✓	1

**mirilla CUADRADA**

referencia	diametro	medida	material	acabado	SK	
573.811.512	16	35 a 60 mm	laton	CROMO MATE	✓	1

Mirilla cuadrada decorativa. Fabricada en latón, con lentes de vidrio, pulido brillante de alta calidad. Para puertas de 35 a 60 mm

**mirilla GRAN DIAMETRO**

referencia	diametro	medida	material	acabado	SK	
573.811.245	22	40 a 60 mm	laton	laton mate	✓	1
573.811.256	22	60 a 80 mm	laton	laton mate	✓	1



**14.19** mirilla digital ELECTRONICA

referencia	diametro	medida	acabado	SK	
573.811.805	14	38 a 110 mm	chromo mate	✓	1
573.811.816	14	38 a 110 mm	dorado	✓	1



Con la nueva Mirilla Digital, podrá sentirse más seguro en su hogar. Una Mirilla Digital de fácil instalación para reemplazar a la mirilla convencional sin trabajos adicionales y aportando mayor seguridad y comodidad a su vivienda. Se instala en perforación de 14mm de mirilla mecánica standard. Válida para diferentes grosores de puertas. De fácil instalación y utilización. Simplemente pulsando un botón podrá ver quien llama a su puerta.

**Especificaciones:**

- Se instala en perforación de 14mm de mirilla mecánica standard
- 128 x 68 x 15mm
- Grosor de puerta 38-110mm
- Pantalla 3.2" LCD
- 76.800 pixels
- Pilas 2 pcs. AAA
- Angulo de visión de 105º

**Características:**

- Imagen diáfana en la pantalla
- Fácil de usar - simplemente pulse el botón
- Apagado automático después de 10 segundos
- Fácil de instalar
- no requiere herramientas
- Reemplaza una mirilla standard sin trabajo adicional



Mirilla desde el exterior





**14.19**

**pasador LATON**

LATON

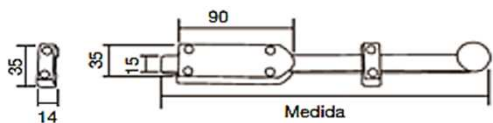

descripcion	medida	pulido brillo	cuero laton patin.	efecto inox	SK	
pasador	200	571.811.735	571.811.746	571.811.750	✓	1
pasador	300	571.811.761	571.811.772	571.811.783	✓	1
pasador	500	571.811.794	571.811.805	571.811.816	✓	1
pasador	1.000	571.811.820	571.811.831	571.811.842	p	1
dedal		571.811.260	571.811.853	571.811.864	✓	1



*Dedal rectangular*

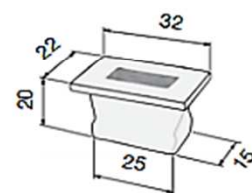

**pasador R/6**

HIERRO FORJADO

descripcion	medida	negro	anticuario	plata vieja	SK	
pasador	150	✓ 571.811.415	571.811.441	571.811.474	p	1
pasador	250	✓ 571.811.426	571.811.452	571.811.485	p	1
pasador	400	✓ 571.811.430	571.811.463	571.811.496	p	1

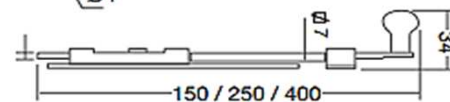
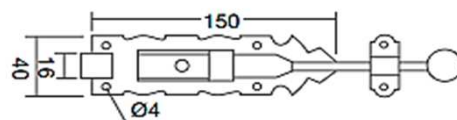

**pasador sobrepuesto fuerte**

ACERO

medida	bicromatado	SK	
200	571.811.221	✓	1
250	571.811.562	✓	1
300	571.811.232	✓	1
400	571.811.142	✓	1

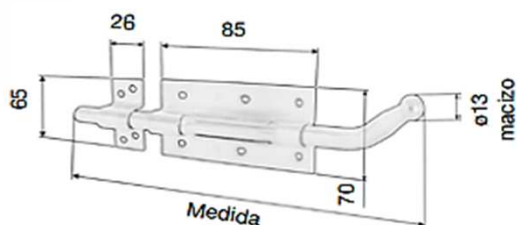

✓ = stock

p = bajo pedido

**manilleria , accesorios**





# 14.19 pasador SOBREPUESTO estandar y reforzado

ALUMINIO



descripcion	A	B	medida	plata	oro	SK	
estandar	16	30	50	571.811.092		✓	1
estandar	16	30	80	571.811.103		✓	1
estandar	16	30	100	571.811.114		✓	1
estandar	16	30	150	571.811.125		✓	1
estandar	16	30	200	571.811.136		✓	1
estandar	16	30	250	571.811.140		✓	1
estandar	16	30	300	571.811.151		✓	1
reforzado	25	40	100	571.811.011	571.811.022	✓	1
reforzado	25	40	150	571.811.033	571.811.044	✓	1
reforzado	25	40	250	571.811.055	571.811.066	✓	1
reforzado	25	40	350	571.811.070	571.811.081	✓	1

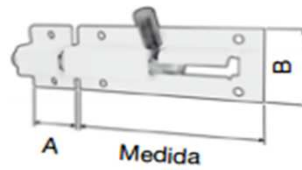

## pasador de CAJA 13 mm

ACERO

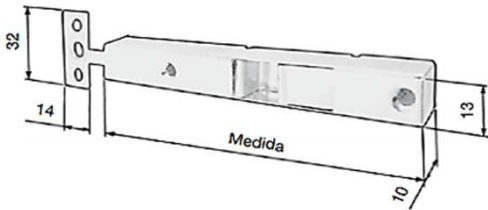

medida	dorado brillo	chromo brillo	SK	
100	571.811.464	571.811.536	✓	1
120	571.811.475	571.811.621	✓	1
160	571.811.484	571.811.540	✓	1



## pasador de CAJA 16 mm

ACERO

descripcion	medida	dorado brillo	chromo brillo	SK	
pasador	150	571.811.405	571.811.595	✓	1
pasador	200	571.811.416	571.811.606	✓	1
pasador	250	571.811.420	571.811.610	✓	1
puente pasador		571.811.105		✓	1

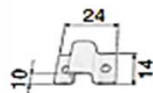

Puente pasador

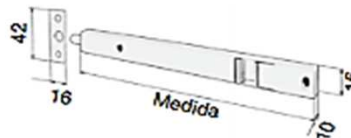



14.19

**pasador EMBUTIDO de palanca 16 mm**

ACERO

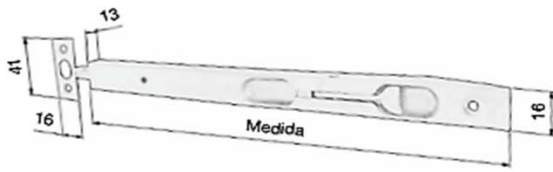

medida	dorado brillo	cromo brillo	inox mate	SK	
160	571.811.265	571.811.330	571.811.573	✓	1
200	571.811.276	571.811.341		✓	1
250	571.811.280	571.811.352		✓	1
300	571.811.291		571.811.584	✓	1

**pasador BOLA plano o con tapabocas de 15 mm**

ACERO

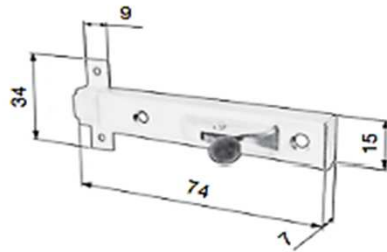

	dorado brillo	cromo brillo	bicromatado	SK	
pasador plano	571.811.083	571.811.061		✓	1
pasador tapabocas	571.811.050	571.811.072		✓	1
tope escuadra			991.811.094	✓	1

**DEDALES redondos**

LATON



A	B	C	D	laton mate	niquelado	SK	
12	20	37	8	571.811.223	571.811.632	✓	1
13	17	37	9	571.811.825		✓	1
15	19	37	11	571.811.836		✓	1
17	21	37	13	571.811.840		✓	1
25	35	44	20	571.811.851		✓	1

**DEDALES redondos RV5**

LATON



A	laton	niquelado	SK	
8	571.131.170	571.131.176	✓	1
10	571.131.171	571.131.177	✓	1
12	571.131.172	571.131.178	✓	1
14	571.131.173	571.131.179	✓	1
20	571.131.174	571.131.180	✓	1
22	571.131.175	571.131.181	✓	1





### 14.19 PUNTILLA acero cabeza perdida

ACE



medida	cincado	SK	img
	413.131.029	✓	1000

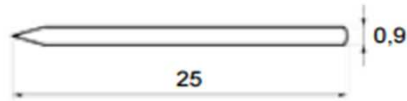

### CUÑA madera

PINO



medida	marron	SK	img
75x35	552.131.575	p	100

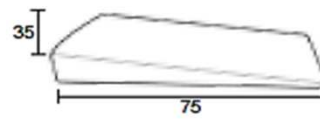

### anclaje V

ACERO



medida	negro	SK	img
30X30	552.131.001	p	1000

### GARRA precerco

ACERO



medida	cincado	SK	img
140X20	552.131.002	p	500

### GARRA precerco PIN

ACERO

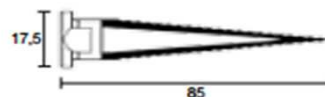

medida	cincado	SK	img
75x35	552.131.003	p	1000

