



**tirador gola "L" para puertas**

ALUMINIO	artículo	plata mate	efecto inox	blanco brillo	negro mate	SK	
1	perfil tirador 4 mts	113.811.860	113.811.941	113.811.871	113.811.882	✓	1
2	jgo tapas terminal interno	113.811.322	113.811.845	113.811.543	113.811.554	✓	1
3	rincon interno tirador	113.811.333	113.811.823	113.811.565	113.811.576	✓	1
4	rincon externo tirador	113.811.344	113.811.834	113.811.580	113.811.591	✓	1
5	kit accesorios fijacion	113.811.381	113.811.381	113.811.381	113.811.381	✓	1



①

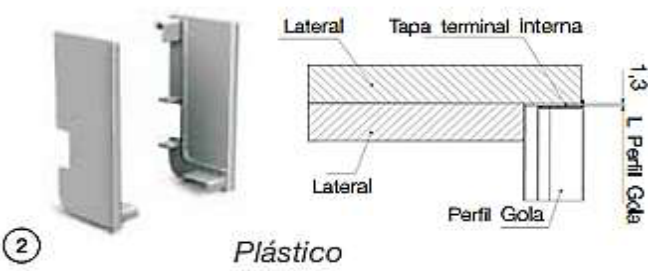
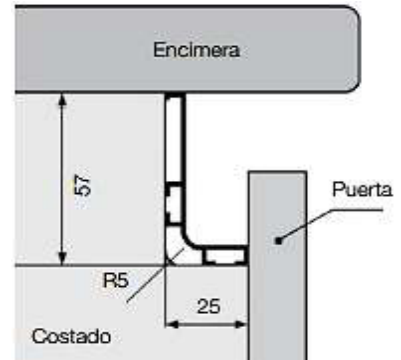

②

Plástico

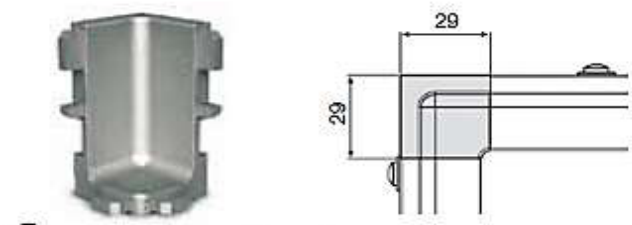

③

Zamak

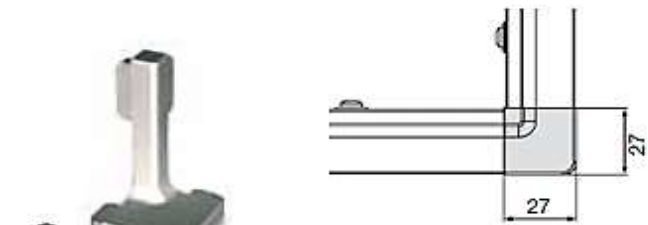

④

Zamak



⑤

**alayne** tiradores





### 21.01 tirador gola "U" para cajon

ALUMINIO

articulo	plata mate	efecto inox	blanco brillo	negro mate	SK	
1 perfil tirador 4 mts	113.811.904	113.811.952	113.811.915	113.811.926	✓	1
2 jgo tapas terminal interno	113.811.370	113.811.856	113.811.646	113.811.650	✓	1
3 kit accesorios fijacion	113.811.381	113.811.381	113.811.381	113.811.381	✓	1

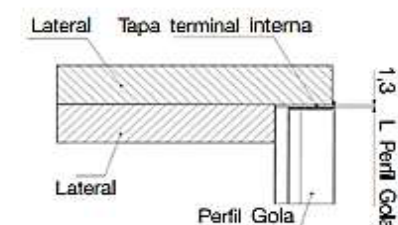
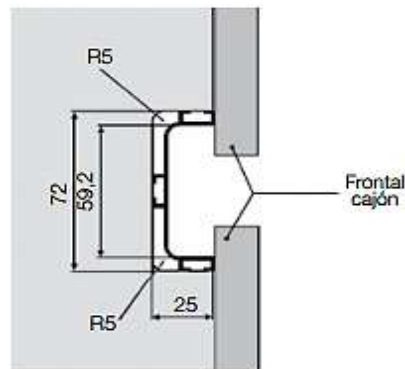

Plástico



### tirador gola VERTICAL para columnas

articulo	plata mate	efecto inox	blanco brillo	negro mate	SK	
1 doble tira 2,30 mts	113.811.103	114.811.033	113.811.011	113.811.022	✓	1
2 simple tira 2,30 mts	113.811.114	114.811.125	113.811.136	113.811.140	✓	1

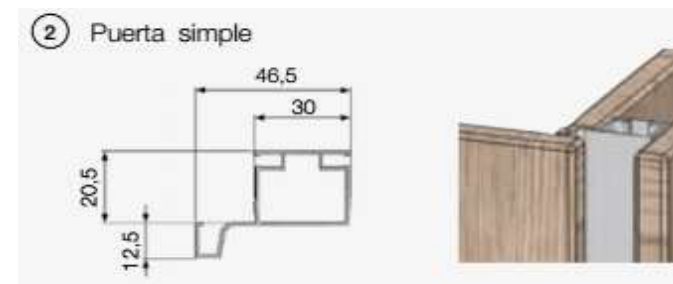
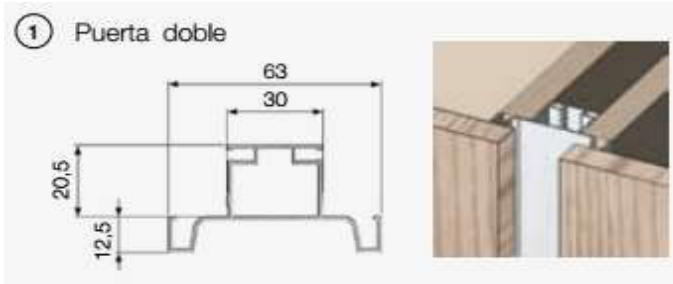

tiradores



b

p= bajo pedido

✓ stock

**tirador gola "H" mueble alto con goma amortiguador**

ALUMINIO

largo	grueso tablero	blanco brillo	plata	SK	
tira 3 mts	16mm	113.811.256	113.811.263	✓	1
tira 3 mts	19mm	113.811.260	113.811.980	✓	1

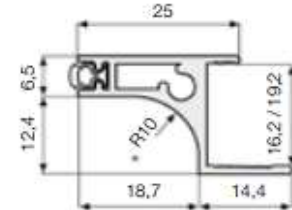
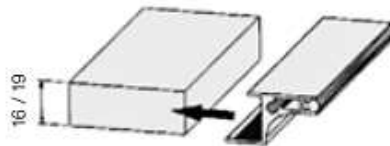
**led ADAM para tirador gola**

wattios mt	voltios	LM	nº leds	cortes	ancho	5500º blanco frio		2700º blanco calido		SK	
						1 mt	5 mt	1 mt	5 mt		
4,8 w	24 v	450 lm	60	100mm	8mm	232.811.950	232.811.961	232.811.935	232.811.946	✓	1
9,6 w	24 v	895 lm	120	50mm	8mm	232.811.994	232.811.005	232.811.972	232.811.983	✓	1

**Características rollo LED:**

- Rollo de 1 ó 5 metros provisto de cableado soldado para su conexión en ambos extremos (intentando evitar soldadura y conectores rápidos).
- Durabilidad de 50.000 horas
- Longitud máxima interconectable de 10 metros.
- No incluye fuente de alimentación, a elegir según el consumo en wattios y según la longitud en metros.
- Ángulo 120º.
- El modelo ADAM se caracteriza por más luminosidad, más homogeneidad de tonos lumínicos y una degradación del Led a las 50.000 horas del 10%.

**Fuente de alimentación (no incluida):**

elemento	wattios	medidas	referencia	SK	
fuelle alimentación	15	128x50x14	331.811.382	✓	1
fuelle alimentación	30	164x43x32	331.811.620	✓	1
fuelle alimentación	60	190x52x57	331.811.404	✓	1

**Cables Led SMD con conector rápido (sin soldadura)**

descripcion	ancho 8 mm	ancho 10 mm	SK	
cable empalme 150 mm	322.811.230	322.811.263	✓	1
cable alimentación 150 mm	322.811.226	322.811.252	✓	1
pieza empalme	322.811.241	322.811.274	✓	1



Empalme\*



Alimentación



Pieza empalme

**IMPORTANTE:**

Los conectores rápidos no sirven para tiras Led con más de 80 Leds al disponer estas de muchos puntos de luz, en ese caso es imprescindible instalación mediante soldadura (tener en cuenta la polaridad)

**Ejemplo de unión conector rápido (sin soldadura) + tira Led**



# 21.01 tirador gola UNICO BILED para puertas **ILUMINADO**

ALUMINIO	artículo	plata mate	blanco mate	oro mate	antracina mate	SK	
1	perfil tirador 4 mts*	113.811.332	113.811.343	113.811.354	113.811.365	✓	1
2	tapa izq+der. Perfil	113.811.380	113.811.413	113.811.472	113.811.446	✓	1
3	rincon perfil	113.811.391	113.811.424	113.811.483	113.811.450	✓	1
4	esquina perfil	113.811.402	113.811.435	113.811.494	113.811.461	✓	1
5	escuadra fijacion	113.811.505	113.811.505	113.811.505	113.811.505	✓	1
6	cubierta PVC 2mm	113.811.376	113.811.376	113.811.376	113.811.376	✓	1

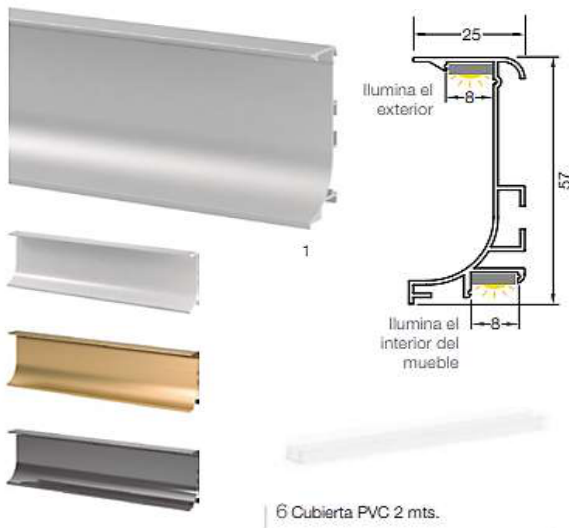

\* Corte en 2 piezas para evitar recargo de transporte superior a 3 metros.

El mismo perfil sirve para puertas o cajones. Dependiendo de la colocación de la tira LED iluminaremos el perímetro o interior del mueble.



## KIT ILUMINACION interior mueble



El kit incluye:  
 1 - Led 4000°K (Luz neutra).  
 2 - Sensor de apertura con encendido automático.  
 3 - Cable conexión.  
 4 - Cubierta PVC

potencia	largo	referencia	SK	
12w	1 mt	232.811.575	✓	1
24w	2 mts	232.811.586	✓	1



## tirador mueble alto BILED para puertas **ILUMINADO**

ALUMINIO	grosor	largo	plata mate	blanco mate	antracina mate	SK	
	16 mm	4 mts*	113.811.516	113.811.520	113.811.531	✓	1
	19mm	4 mts*	113.811.542	113.811.553	113.811.564	✓	1

\* Corte en 2 piezas para evitar recargo de transporte superior a 3 metros.

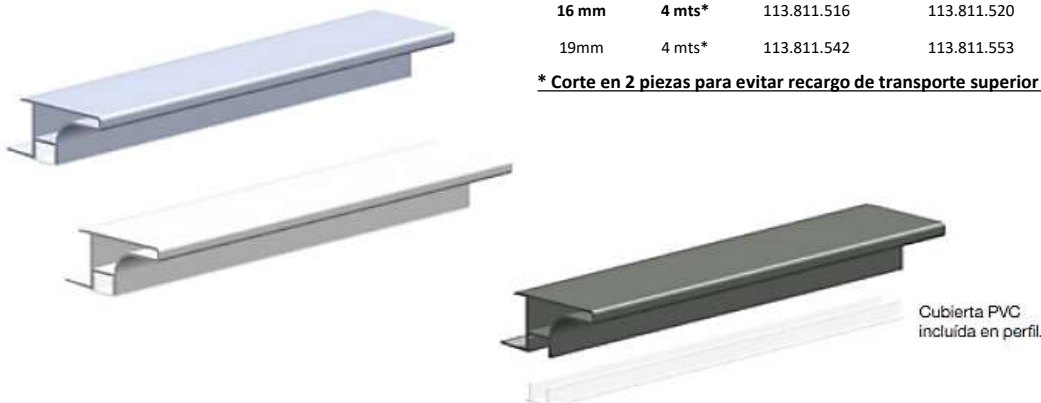



**tirador gola PLANO horizontal y vertical para puertas**



descripcion	plata mate	efecto inox	blanco brillo	SK	
perfil tirador 4,7 mts	113.811.972	113.811.983	113.811.994	✓	1

GOLA PLANO Vertical

GOLA PLANO Vertical

GOLA PLANO Horizontal

**tirador gola PLANO horizontal y vertical para cajon**



descripcion	plata mate	efecto inox	blanco brillo	SK	
perfil tirador 4,7 mts	113.811.005	113.811.016	113.811.965	✓	1

GOLA PLANO Vertical

GOLA PLANO Vertical

GOLA PLANO Horizontal

**tirador gola PLANO horizontal y vertical soportes y distanciadores**



descripcion	negro	SK	
soporte	113.811.031	✓	1
distanciador	113.811.042	✓	1

**tirador GRADA pestaña**

ALUMINIO



mueble	A	plata mate	SK	
m-15	147	111.811.192	✓	1
m-20	197	111.811.203	✓	1
m-25	247	111.811.214	✓	1
m-30	297	111.811.225	✓	1
m-35	347	111.811.236	✓	1
m-40	397	111.811.240	✓	1
m-45	447	111.811.251	✓	1
m-50	497	111.811.262	✓	1
m-60	597	111.811.273	✓	1
m-70	697	111.811.284	✓	1
m-80	797	111.811.295	✓	1
m-90	897	111.811.306	✓	1
m-100	997	111.811.310	✓	1
m-120	1197	111.811.321	✓	1
barra 3 mts		111.811.332	✓	1

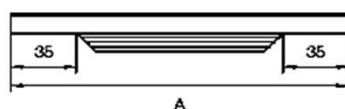
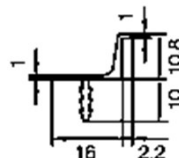

✓ = stock

p = bajo pedido

# 21.01 tirador gola TOUCH para puertas

ALUMINIO/zamak

artículo	chromo mate	SK	
kit perfil 1 mt+2 bisagras	113.811.924		15
kit 1 perfil 3 mts+6 bisagras	113.811.854		15
bisagra suelta	113.811.865		1



Permite instalación a todo el largo de la puerta o cajón, o a la medida que se desee. El perfil de aluminio satinado viene provisto de tratamiento para poderlo lacar al color de la puerta y permitir integrarlo al diseño necesario.

Este revolucionario producto permite embutir un perfil tirador con bisagra en cualquier cajón para mueble o puerta de armario corredera. Un estilizado perfil de tres metros en acabado chromo mate le permitirá, por ejemplo, instalar un perfil que abarque toda la altura de un armario corredero. Aunque si lo prefiere puede cortar dicho perfil e instalar su tirador TOUCH a la medida que desee.

La personalización que ofrece el sistema TOUCH no se queda ahí, el perfil de aluminio satinado en acabado chromo mate viene provisto de un tratamiento para poderlo lacar al color de la puerta del mueble o el armario. Así podemos integrar el sistema TOUCH en cualquier tipo de diseño. Súbase al carro de la personalización, del minimalismo, del detalle y de la calidad con el sistema perfil TOUCH.

Medidas bisagra

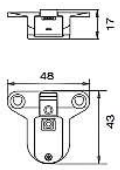

Número de bisagras según puerta

Puerta	Bisagras
150 a 1099 mm.	2
1100 a 1599 mm.	3
1600 a 2099 mm.	4
2100 a 2599 mm.	5
2600 a 3000 mm.	6

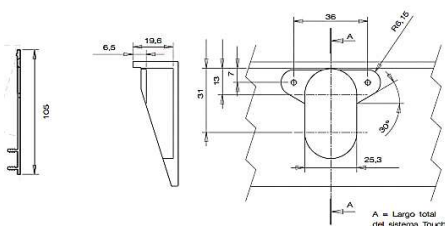

Ejemplos de montaje

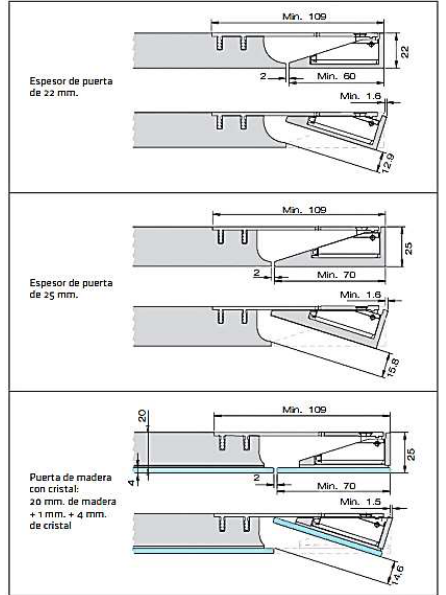

## tirador MITER angulo cualquier grueso puerta

ALUMINIO

mueble	A	plata mate	SK	
m-15	147	112.811.192		1
m-20	197	112.811.203		1
m-25	247	112.811.214		1
m-30	297	112.811.225		1
m-35	347	112.811.236		1
m-40	397	112.811.240		1
m-45	447	112.811.252		1
m-50	497	112.811.262		1
m-60	597	112.811.273		1
m-70	697	112.811.284		1
m-80	797	112.811.295		1
m-90	897	112.811.306		1
m-100	997	112.811.310		1
m-120	1197	112.811.321		1

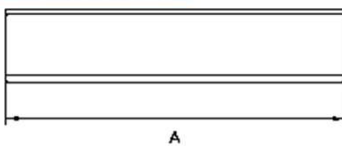
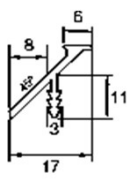

tiradores



p= bajo pedido

stock

**tirador JEV pestaña**

ALUMINIO

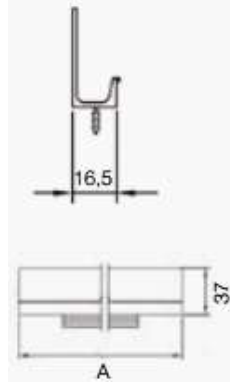

mueble	A	efecto inox	SK	
m-15	147	111.811.985	✓	1
m-20	197	111.811.926	✓	1
m-25	247	111.811.000	✓	1
m-30	297	111.811.011	✓	1
m-35	347	111.811.022	✓	1
m-40	397	111.811.033	✓	1
m-45	447	111.811.044	✓	1
m-50	497	111.811.055	✓	1
m-60	597	111.811.066	✓	1
m-70	697	111.811.070	✓	1
m-80	797	111.811.081	✓	1
m-90	897	111.811.092	✓	1
m-100	997	111.811.103	✓	1
m-120	1197	111.811.114	✓	1

**tirador JEV-2 pestaña**

ALUMINIO



mueble	A	efecto inox	SK	
m-15	147	111.811.674	✓	1
m-20	197	111.811.675	✓	1
m-25	247	111.811.696	✓	1
m-30	297	111.811.700	✓	1
m-35	347	111.811.721	✓	1
m-40	397	111.811.722	✓	1
m-45	447	111.811.733	✓	1
m-50	497	111.811.744	✓	1
m-60	597	111.811.755	✓	1
m-70	697	111.811.766	✓	1
m-80	797	111.811.770	✓	1
m-90	897	111.811.781	✓	1
m-100	997	111.811.792	✓	1
m-120	1197	111.811.823	✓	1

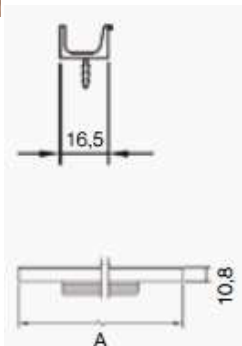

**tirador GOBE pestaña**

ALUMINIO

Permite cualquier grueso de puerta al no tener pestaña posterior.

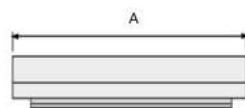
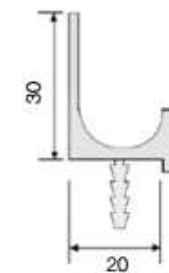

mueble	A	efecto inox	SK	
m-25	247	111.811.686	✓	1
m-30	297	111.811.690	✓	1
m-35	347	111.811.701	✓	1
m-40	397	111.811.712	✓	1
m-45	447	111.811.723	✓	1
m-50	497	111.811.734	✓	1
m-60	597	111.811.745	✓	1
m-70	697	111.811.756	✓	1
m-80	797	111.811.760	✓	1
m-90	897	111.811.771	✓	1
m-100	997	111.811.782	✓	1
m-120	1197	111.811.793	✓	1





### 21.01 tirador TECNO pestaña

ALUMINIO

Permite cualquier grueso de puerta al no tener pestaña posterior.



mueble	A	B	efecto inox	SK	
m-25	247	207	111.811.660	✓	1
m-30	297	257	111.811.671	✓	1
m-35	347	307	111.811.682	✓	1
m-40	397	357	111.811.693	✓	1
m-45	447	407	111.811.704	✓	1
m-50	497	457	111.811.715	✓	1
m-60	597	557	111.811.726	✓	1
m-70	697	657	111.811.730	✓	1
m-80	797	757	111.811.741	✓	1
m-90	897	857	111.811.752	✓	1
m-100	997	967	111.811.773	✓	1
m-120	1197	1157	111.811.784	✓	1

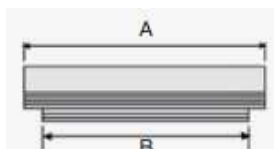
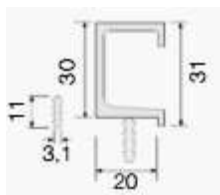

### tirador SWING

ACERO INOX

C	L	acero inox	SK	
16	32	111.811.245	✓	1

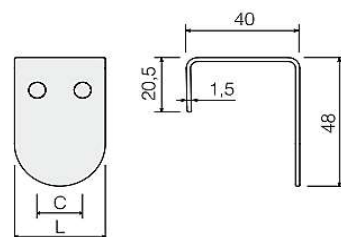

### tirador EDGE FILIGREE

ALUMINIO

Fácil instalación

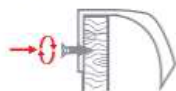

\* Tiradores con 3 agujeros a 80 mm de distancia

		titanio cepillado	SK	
20	60	111.811.024	✓	1
160*	176	111.811.035	✓	1

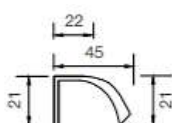

### tirador ONIDA

ACERO

		plata vieja	negro industrial	SK	
20		111.811.774	111.811.763	✓	1
160	200	111.811.996	111.811.785	✓	1



Fácil instalación

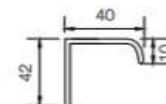
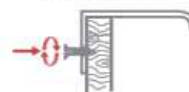



**tirador EDGE STRAIGHT**

ALUMINIO

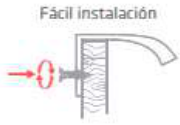

			oro mate	oro rosa mate	moka	negro cepillado	SK	
20	40		111.811.803	111.811.845	111.811.840	111.811.002	✓	1
160*	200		111.811.814	111.811.836	111.811.851	111.811.013	✓	1

\* Tiradores con 3 agujeros a 80 mm de distancia

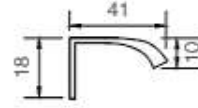

**tirador EDGE ROUND**

ALUMINIO

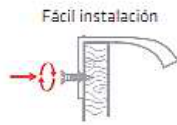

			efecto inox	SK	
20	40		111.811.416	✓	1
160*	200		111.811.420	✓	1

\* Tiradores con 3 agujeros a 80 mm de distancia

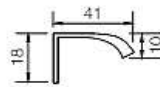

**tirador IZAR adhesivo directo al canto de la puerta**

ALUMINIO

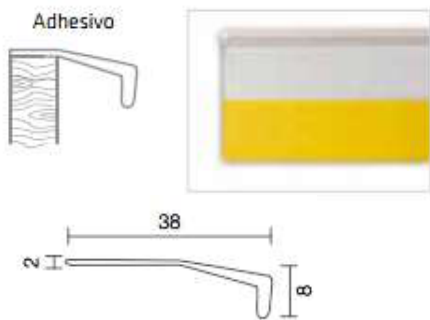

			aluminio plata	SK	
adhesivo	150		111.811.990	✓	1



**placa MOLTO Adhesiva para puertas push**

ALUMINIO



Placa indicadora para facilitar la apertura en ins- talación en puertas o cajones con apertura "push" (o toca-toca).

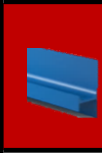

### 21.01 tirador LINEAR con pestaña efecto inox

ALUMINIO

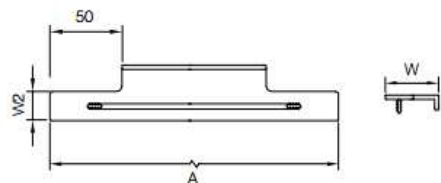

Puerta 19 mm. W2 = 19,8 mm. / W = 37 mm.  
Puerta 20,5 mm. W2 = 21 mm. / W = 38,5 mm.

mueble	A	puerta 19mm	puerta 20,5mm	SK	
m-15	148	111.811.316	111.811.456	✓	1
m-20	198	111.811.320	111.811.460	✓	1
m-25	248	111.811.331	111.811.471	✓	1
m-30	298	111.811.342	111.811.482	✓	1
m-35	348	111.811.353	111.811.493	✓	1
m-40	398	111.811.364	111.811.504	✓	1
m-45	448	111.811.375	111.811.515	✓	1
m-50	498	111.811.386	111.811.526	✓	1
m-60	598	111.811.390	111.811.530	✓	1
m-70	698	111.811.401	111.811.541	✓	1
m-80	798	111.811.412	111.811.552	✓	1
m-90	898	111.811.423	111.811.563	✓	1
m-100	998	111.811.434	111.811.574	✓	1
m-120	1198	111.811.445	111.811.585	✓	1

### tirador FORMA con pestaña efecto inox

ALUMINIO

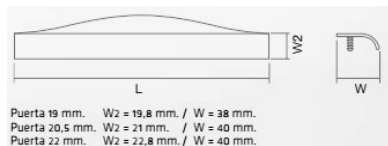

Puerta 19 mm. W2 = 19,8 mm. / W = 38 mm.  
Puerta 20,5 mm. W2 = 21 mm. / W = 40 mm.  
Puerta 22 mm. W2 = 22,8 mm. / W = 40 mm.



mueble	L	puerta 19mm	puerta 20,5mm	puerta 22mm	SK	
m-15	147	✓ 101.811.850	101.811.990	101.811.130	P	1
m-20	197	✓ 101.811.861	101.811.001	101.811.141	P	1
m-25	247	✓ 101.811.872	101.811.012	101.811.152	P	1
m-30	297	✓ 101.811.883	101.811.023	101.811.163	P	1
m-35	347	✓ 101.811.894	101.811.034	101.811.174	P	1
m-40	397	✓ 101.811.905	101.811.045	101.811.185	P	1
m-45	447	✓ 101.811.916	101.811.056	101.811.196	P	1
m-50	497	✓ 101.811.920	101.811.060	101.811.200	P	1
m-60	597	✓ 101.811.931	101.811.071	101.811.211	P	1
m-70	697	✓ 101.811.942	101.811.082	101.811.222	P	1
m-80	797	✓ 101.811.953	101.811.093	101.811.233	P	1
m-90	897	✓ 101.811.964	101.811.104	101.811.244	P	1
m-100	997	✓ 101.811.975	101.811.115	101.811.255	P	1
m-120	1197	✓ 101.811.846	101.811.986	101.811.126	P	1

### tirador TURIN mecanizacion teton

ZAMAK

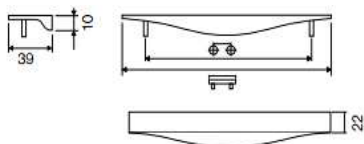

		efecto inox mate	Cromo brillo	SK	
96	146	111.811.999	111.811.130	✓	1
192	280	111.811.001	111.811.141	✓	1
384	446	111.811.012	111.811.152	✓	1



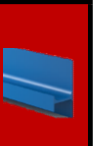

**tirador EMOTIONS TWO atornillar**

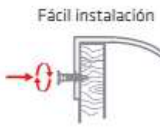
ALUMINIO			efecto inox	blanco mate	negro mate	SK	
----------	--	--	-------------	-------------	------------	----	--

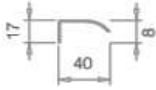
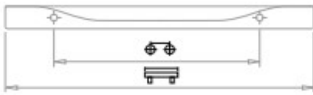

\*3 agujeros, múltiplo 256

128	200	111.811.740	111.811.681	111.811.714	✓	1
256	350	111.811.751	111.811.692	111.811.725	✓	1
512*	650	111.811.670	111.811.703	111.811.736	✓	1



Nota: Se pueden fabricar medidas especiales bajo encargo.  
Pedido mínimo de 200 uds en medidas cortas y 100 en largas

**tirador LIPS atornillar**

ALUMINIO			Cromo brillo	efec. inox mate	SK	
----------	--	--	--------------	-----------------	----	--

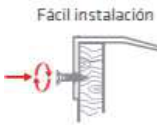

45	160	200	111.811.484	111.811.673	✓	1
45	224	350	113.811.506	113.811.495	✓	1

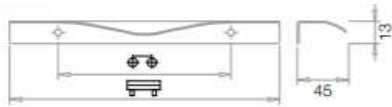

**tirador SLIM-2**

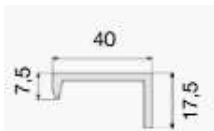
ALUMINIO		aluminio plata	Cromo brillo	blanco mate	negro mate	SK	
----------	--	----------------	--------------	-------------	------------	----	--

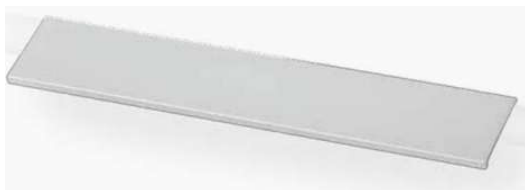

40				111.811.790	111.811.393	✓	1
230		111.811.323	111.811.334	111.811.786	111.811.356	✓	1
2000		111.811.404				✓	1

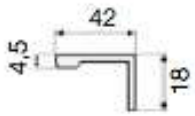

**21.01 ALUMINIO**

\*5 agujeros, múltiplo 224.

			aluminio plata	SK	
	32	40	111.811.842	✓	1
	160	192	111.811.853	✓	1
*5 agujeros, múltiplo 224.	896*	1000	111.811.864	✓	1

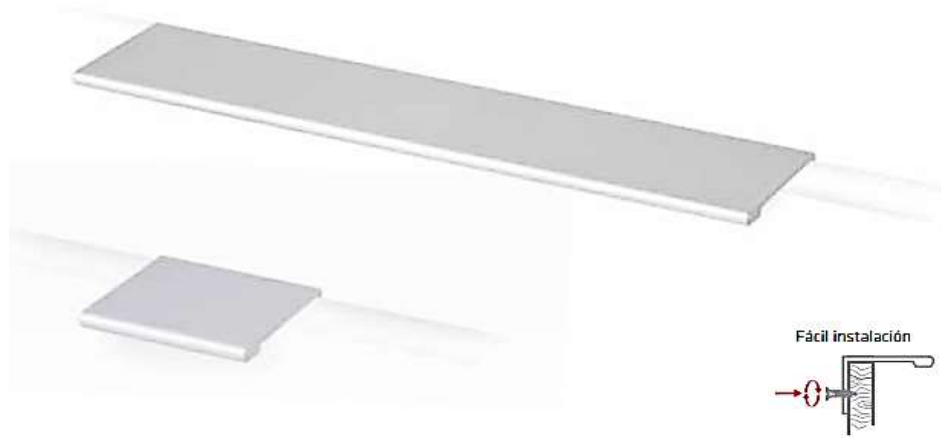
**tirador RESORT**

ALUMINIO

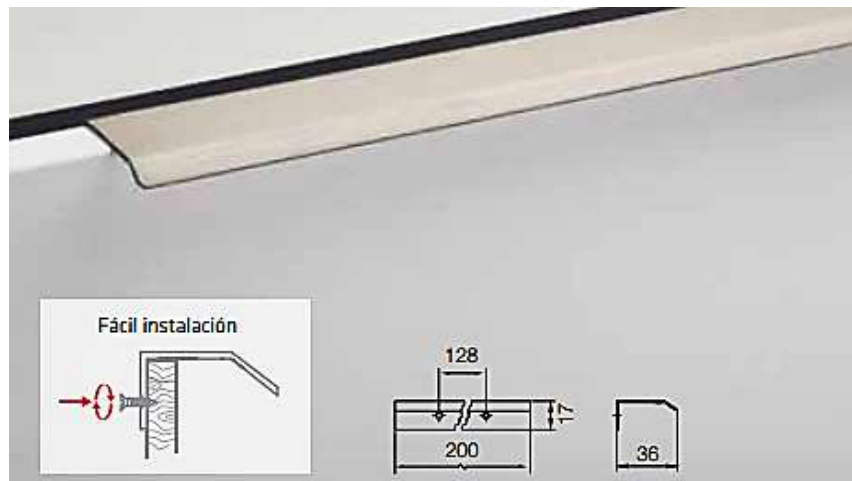

			titanio	efec.inox mate	blanco mate	negro mate	SK	
	128	200	111.811.600	111.811.570	111.811.581	111.811.592	✓	1

**tirador IN**

ACERO INOX

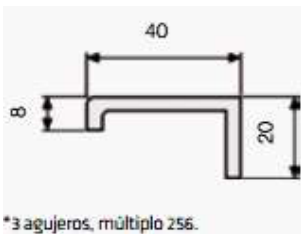

\*3 agujeros, múltiplo 256.

			acero inox	SK	
	16	146	111.811.735	✓	1
	128	280	111.811.746	✓	1
	224	446	111.811.750	✓	1
	512*	544	111.811.761	✓	1

